

# SINGER

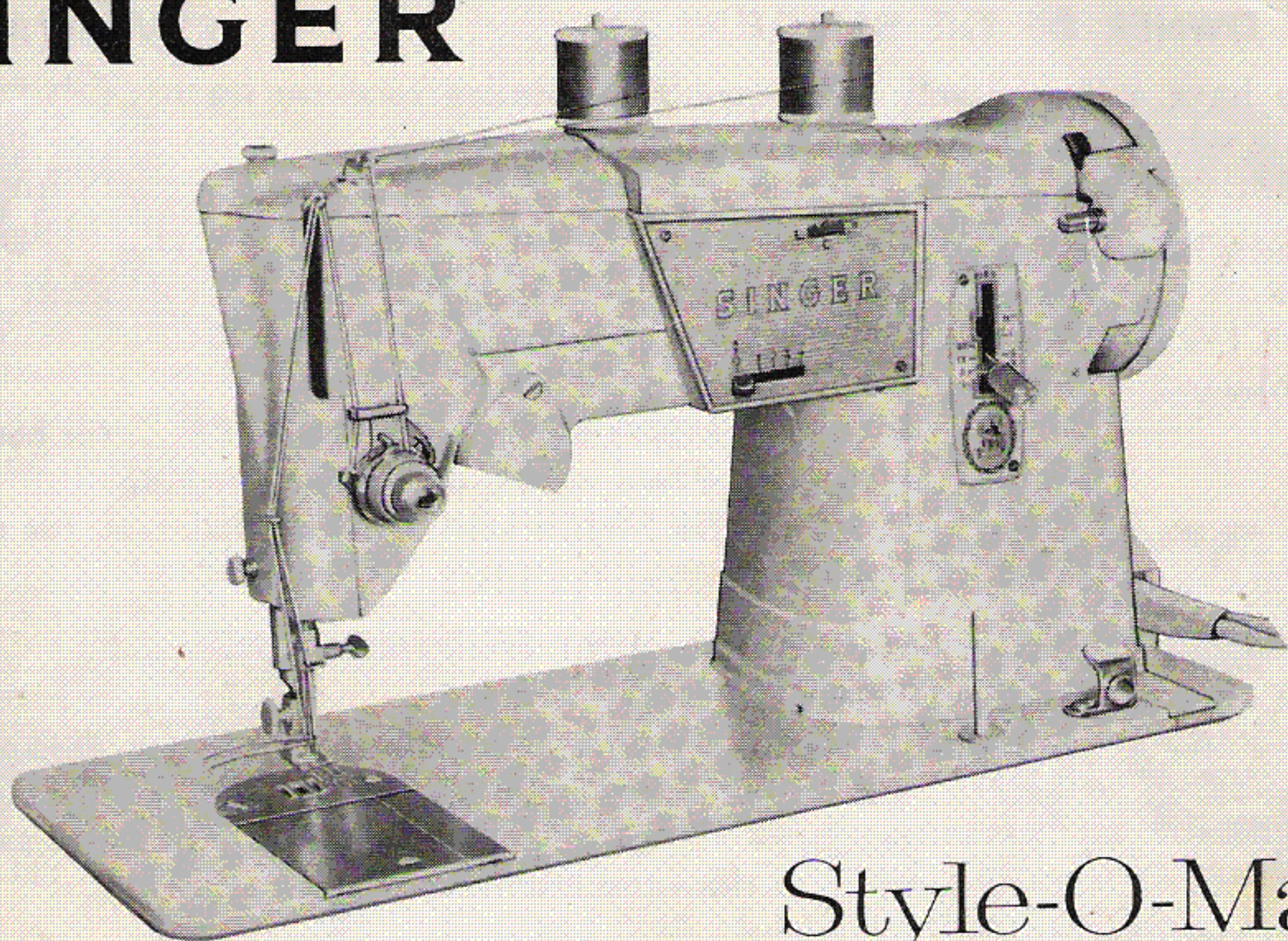

Style-O-Matic<sup>\*</sup>

**sewing machine model 328**

<sup>\*</sup> A Trademark of THE SINGER MANUFACTURING COMPANY

## AS THE OWNER OF THE SINGER\* 328 . . . .

you have a completely new, smooth running automatic which offers you a new world of sewing enjoyment.

### Outstanding features include

- "DROP-IN" BOBBIN . . . located in *front* of needle.
- CLAMP-TYPE CALIBRATED THROAT PLATE . . . easy to remove.

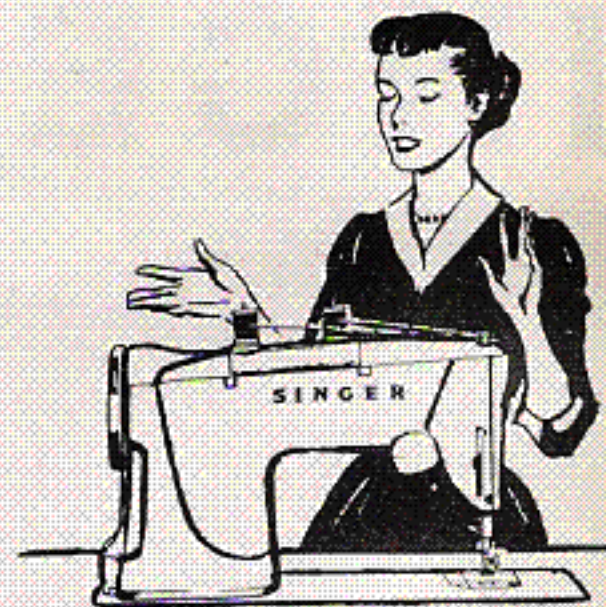

- INTERCHANGEABLE FASHION\* DISCS . . . for beautiful one or two needle decorative stitching.
- SUPERFINE STITCH LENGTH CONTROL . . . for satin stitching.

### TO GET THE MOST ENJOYMENT FROM YOUR SINGER . . .

take advantage of the free sewing lessons to which you are entitled. Skilled, SINGER-trained teachers will give you personal guidance and assistance in the fundamentals of home sewing.

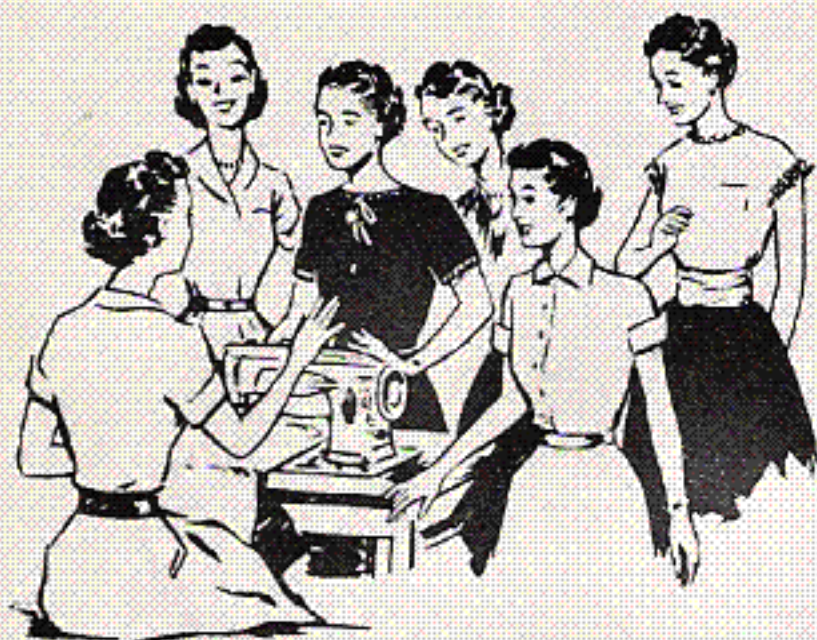

## SINGER SERVICE

Wherever you go you will find expert, dependable SINGER\* Service close at hand. SINGER is interested in helping you keep your SINGER Sewing Machine in top running condition. That is why you should always call your SINGER SEWING CENTER if your machine ever requires adjustment or repair. Only from your SINGER SEWING CENTER can you obtain the services of a trained SINGER repairman and warranted SINGER\* parts.

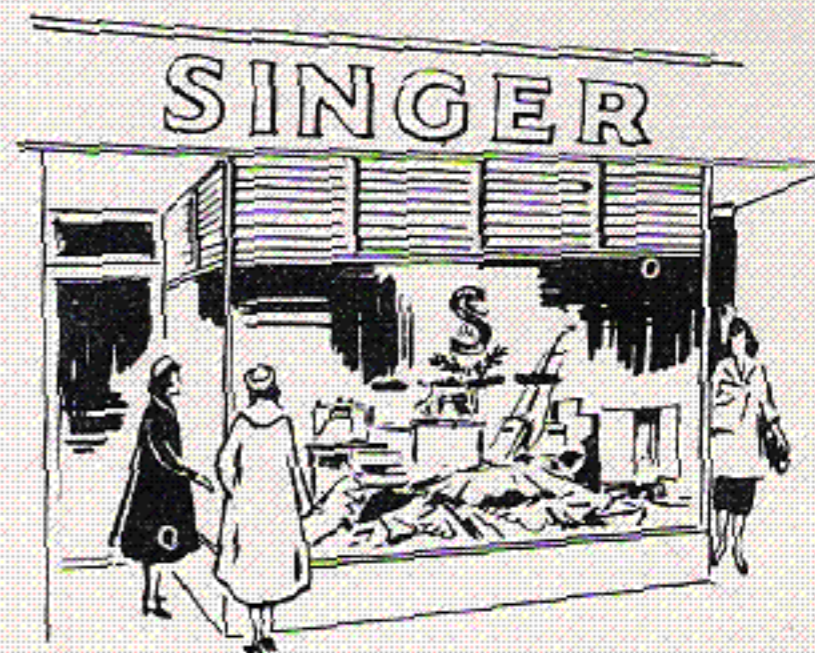

## EVERYTHING FOR THE WOMAN WHO SEWS

The answer to your sewing needs is at your SINGER SEWING CENTER. There you will find a wide choice of sewing aids, notions, sewing instructions and services. Look for the famous red "S" and SINGER trademarks on your SINGER SEWING CENTER and the ever ready SINGER Service Van. Look under SINGER SEWING MACHINE COMPANY, in phone book, for address nearest you.

# PRINCIPAL PARTS OF MACHINE 328

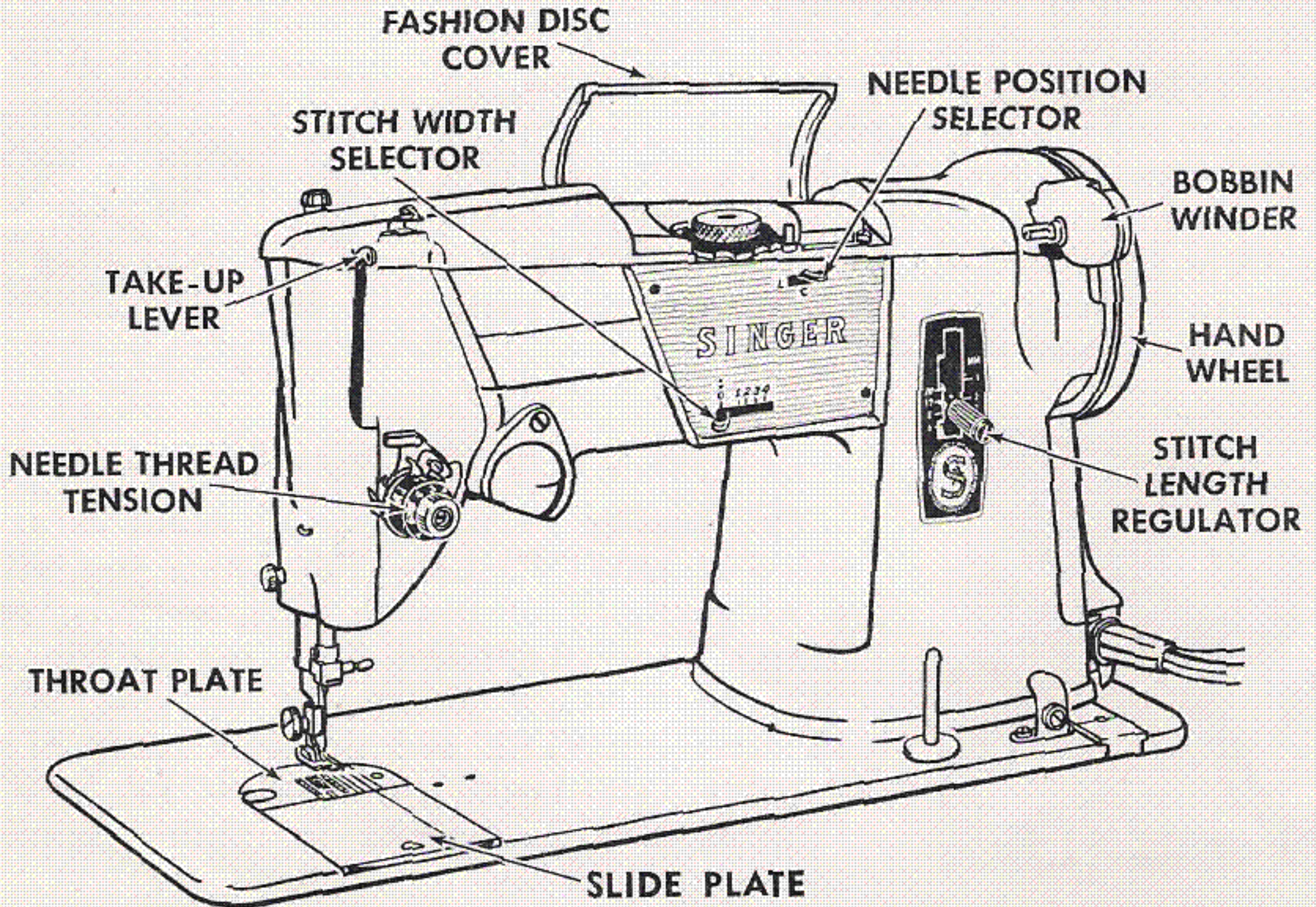

## FABRIC, THREAD, NEEDLE AND STITCH LENGTH CHART

FABRICS	THREAD SIZES	NEEDLE SIZES	MACHINE STITCHES PER INCH STRAIGHT STITCHING
<b>DELICATE</b> —tulle, chiffon, fine lace, silk, organdy, fine tricot	Fine Mercerized 100 to 150 Cotton Synthetic Thread	9	15 to 20
<b>LIGHTWEIGHT</b> —batiste, organdy, jersey, voile, taffeta, silk crepe, plastic film	50 Mercerized 80 to 100 Cotton A Silk Synthetic Thread	11	12 to 15 (8 to 10 for plastic)
<b>MEDIUM WEIGHT</b> —gingham, percale, pique, linen, chintz, faille, satin, fine corduroy, suitings	50 Mercerized 60 to 80 Cotton A Silk Synthetic Thread	14	12 to 15
<b>MEDIUM HEAVY</b> —gabardine, tweed, sail-cloth, denim, coatings, drapery fabrics	Heavy Duty Merc. 40 to 60 Cotton	16	10 to 12
<b>HEAVY</b> —overcoatings, dungaree, upholstery fabrics, canvas	Heavy Duty Merc. 24 to 40 Cotton	18	8 to 10

## NEEDLES AND THREAD

This machine uses needle, Catalog 2020 (15 x 1). Sizes 9, 11, 14, 16 and 18.

For perfect stitching, select correct needle and thread to correspond with fabric according to table on page 5. Be sure to use like threads for both needle and bobbin.

### NEEDLE INSERTION

- Raise needle bar to highest point by turning hand wheel toward you.
- Loosen needle clamp screw.
- Insert needle upward into clamp as far as it will go, with flat side of needle to back and **long groove toward you**.
- Tighten needle clamp screw.

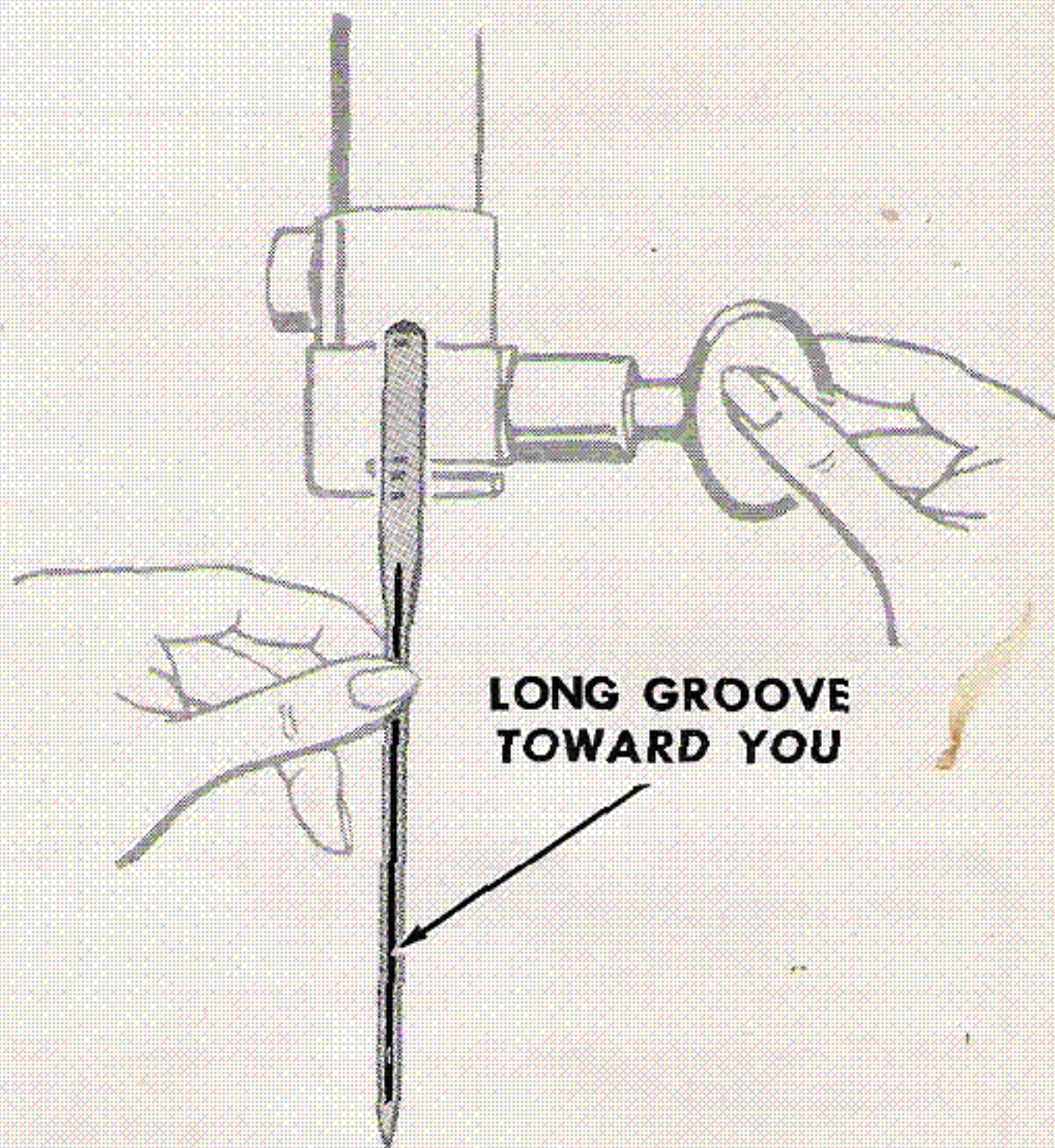

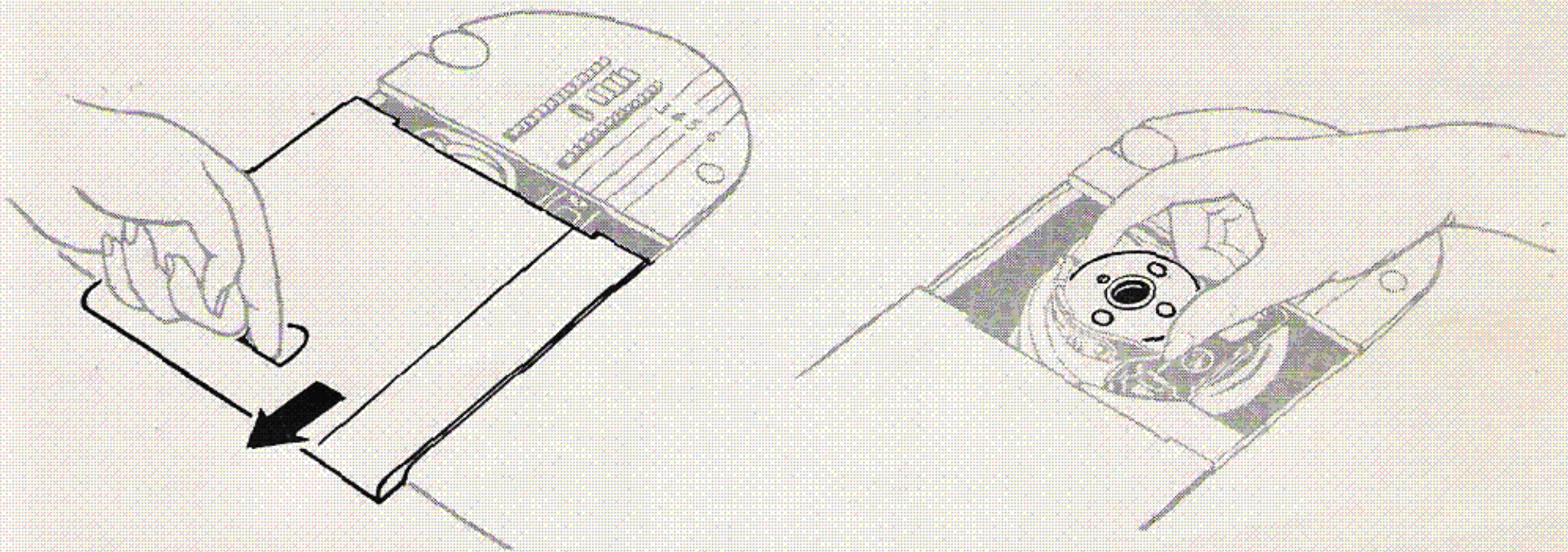
**REMOVING THE BOBBIN**

*Open slide plate and lift out bobbin.*

## WINDING THE BOBBIN

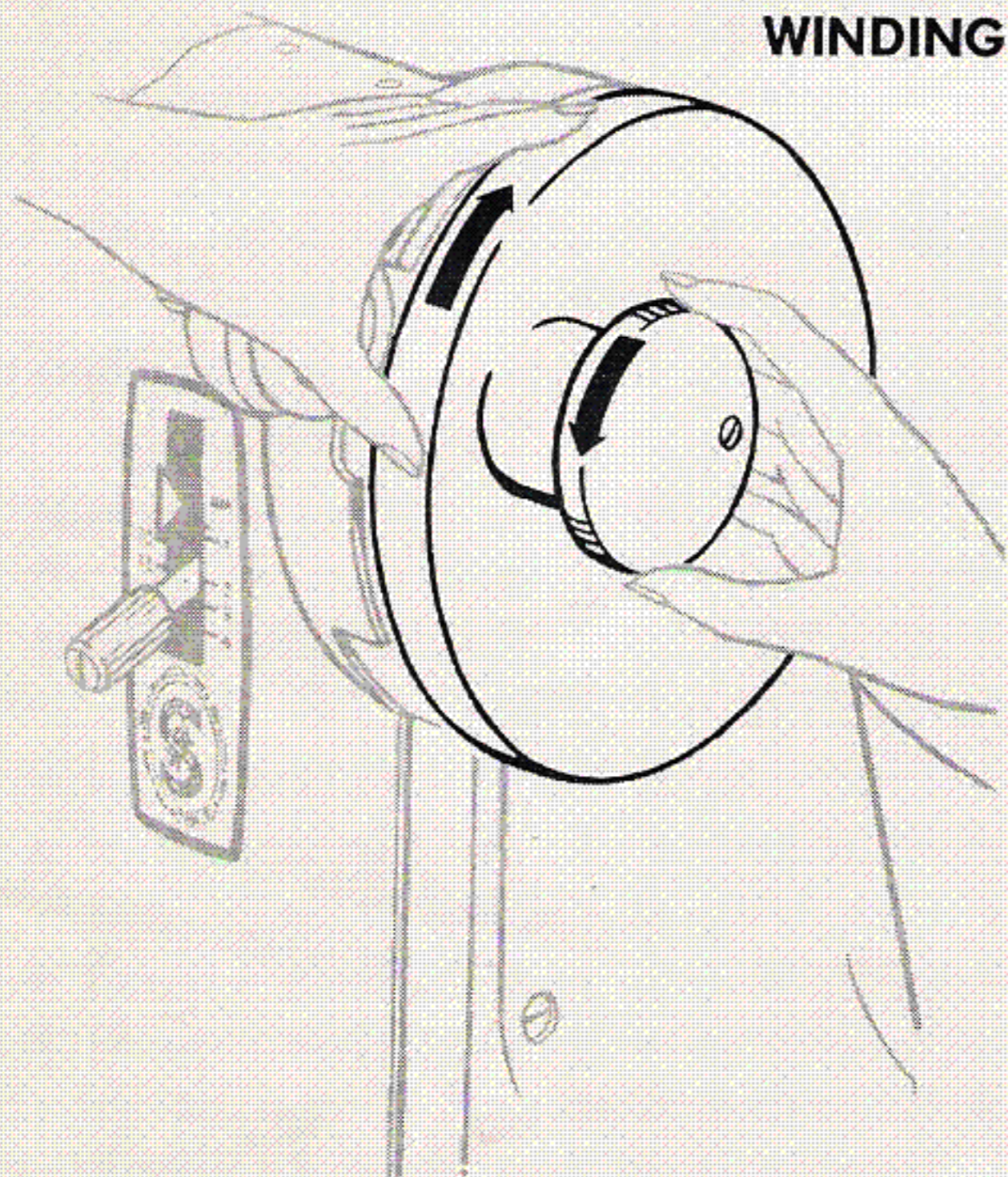

- Loosen stop motion screw with right hand.

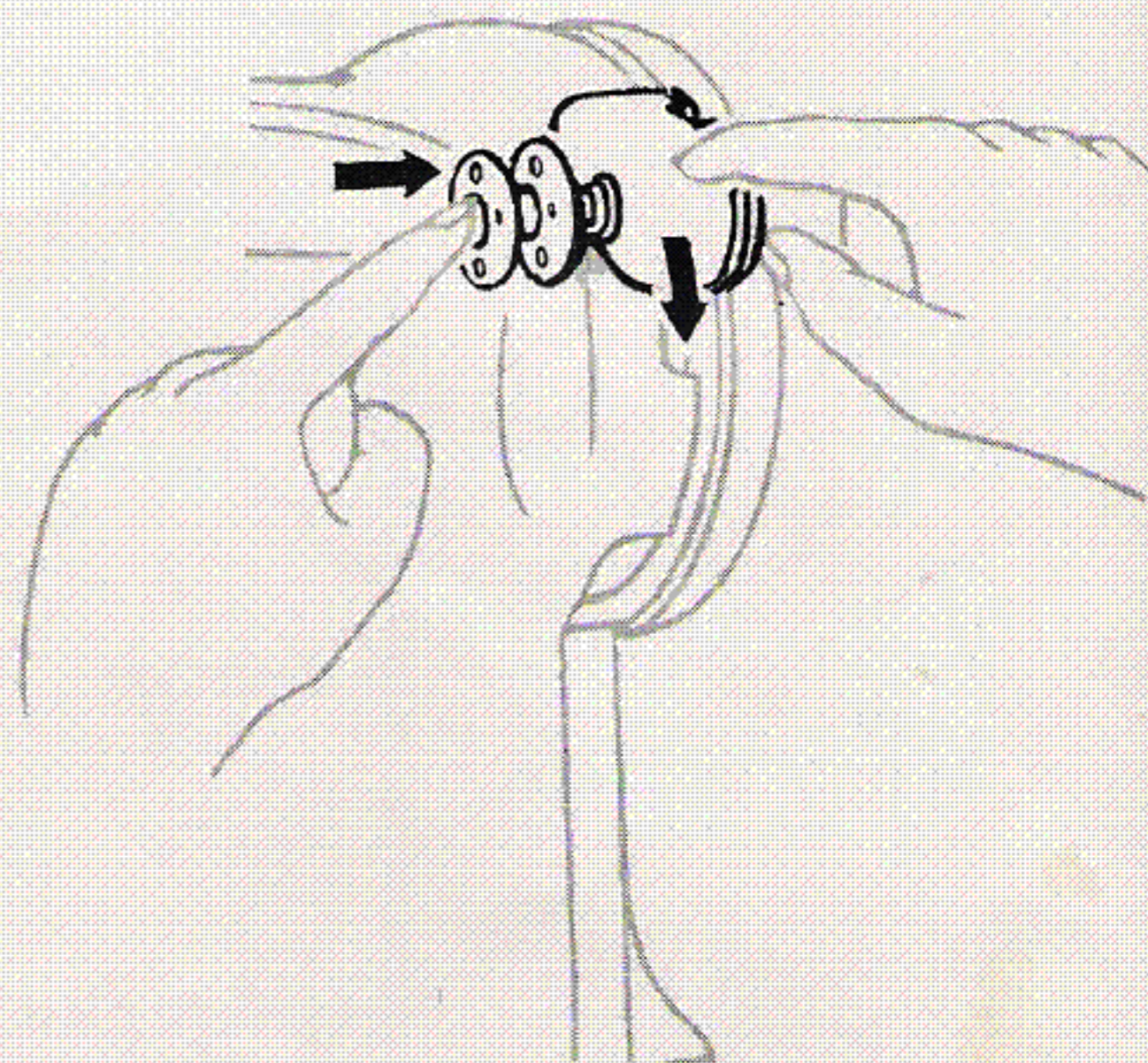

- Place empty bobbin on spindle.
- Press bobbin winder down against hand wheel.



## WINDING THE BOBBIN (Cont'd)

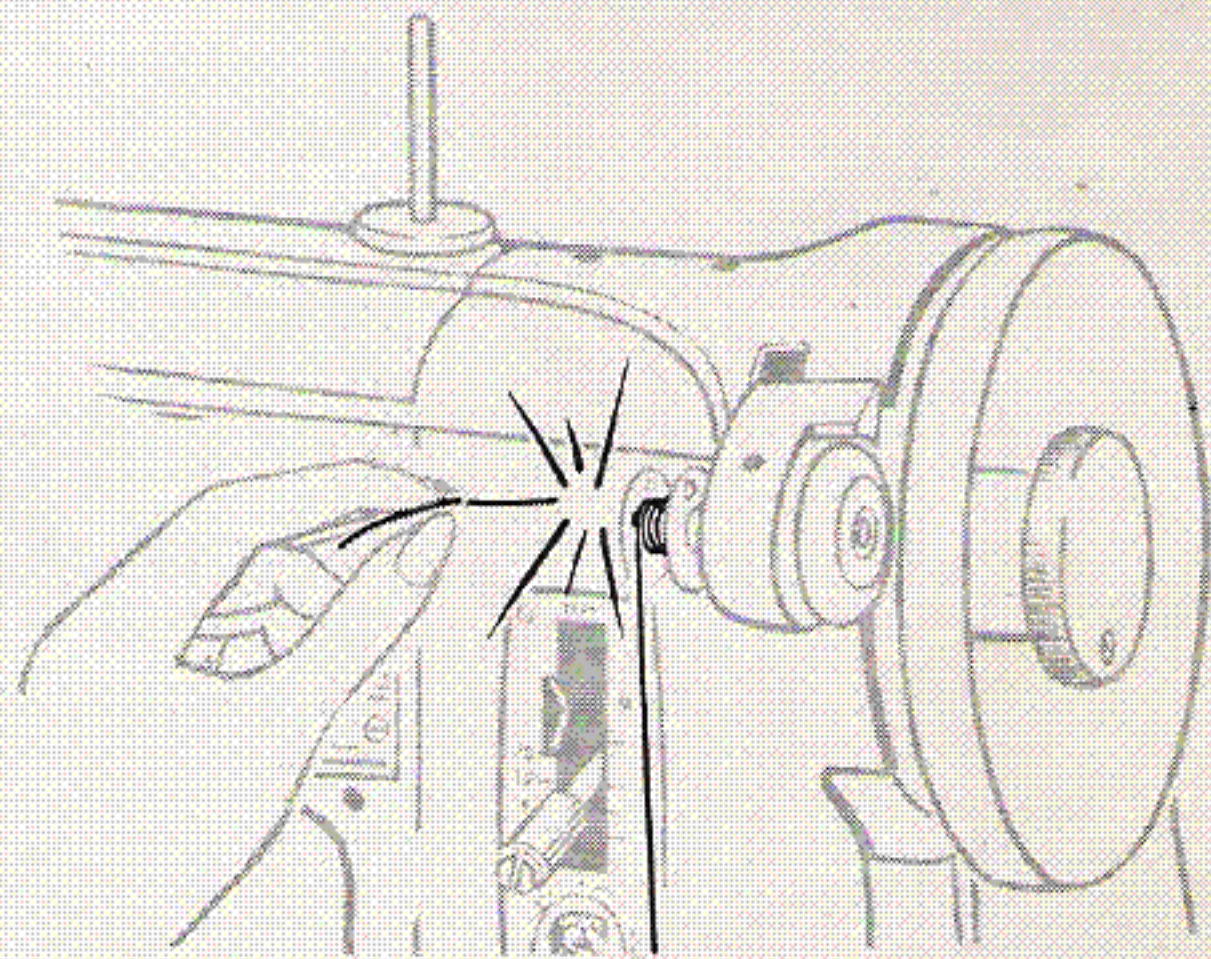
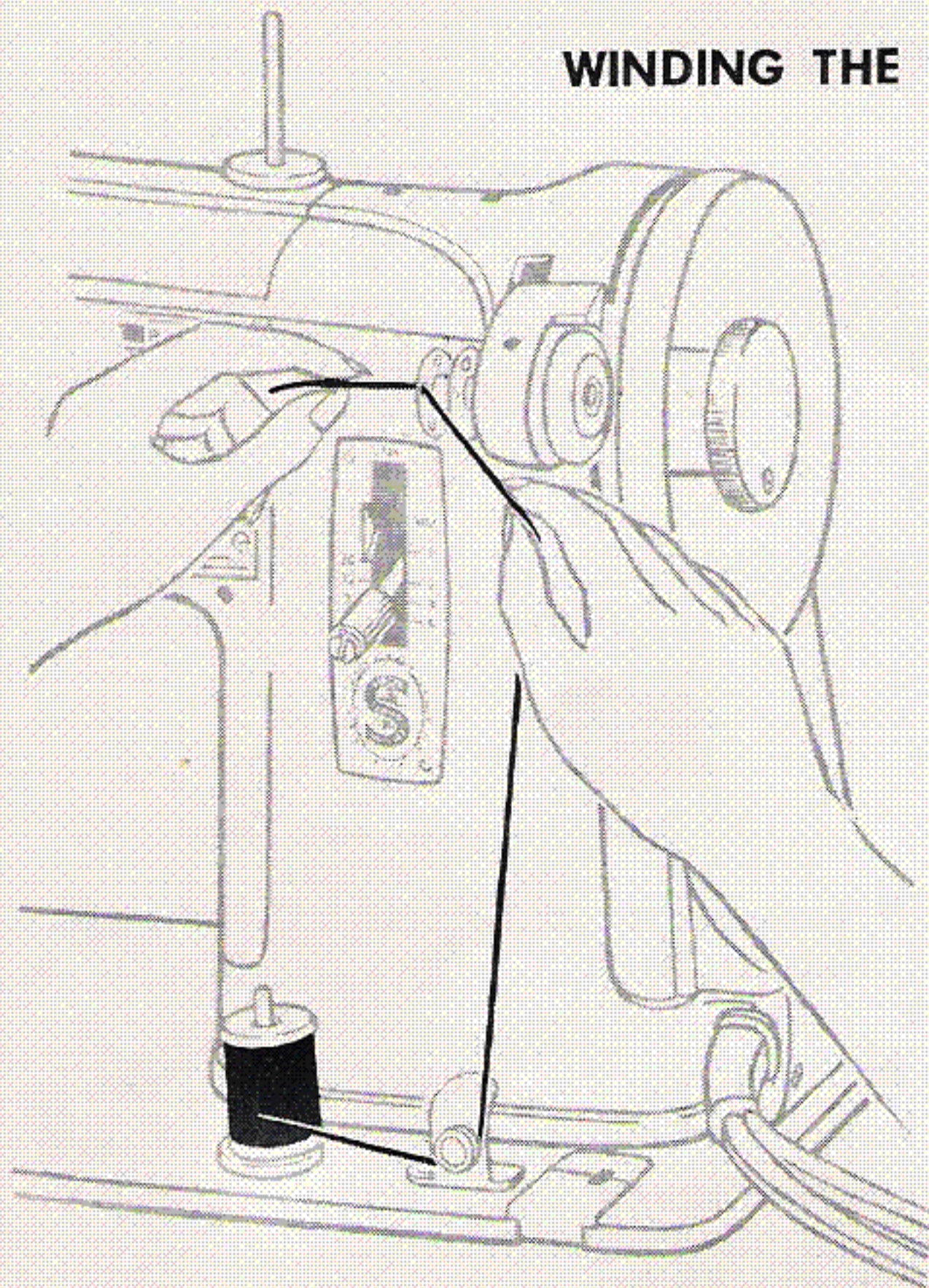

- Place spool of thread on spool pin.
- Thread between tension discs and through bobbin as shown.
- Hold end of thread and start machine. (End of thread will break off after a few coils have been wound on bobbin.)

## WINDING THE BOBBIN (Cont'd)

*When bobbin is full*

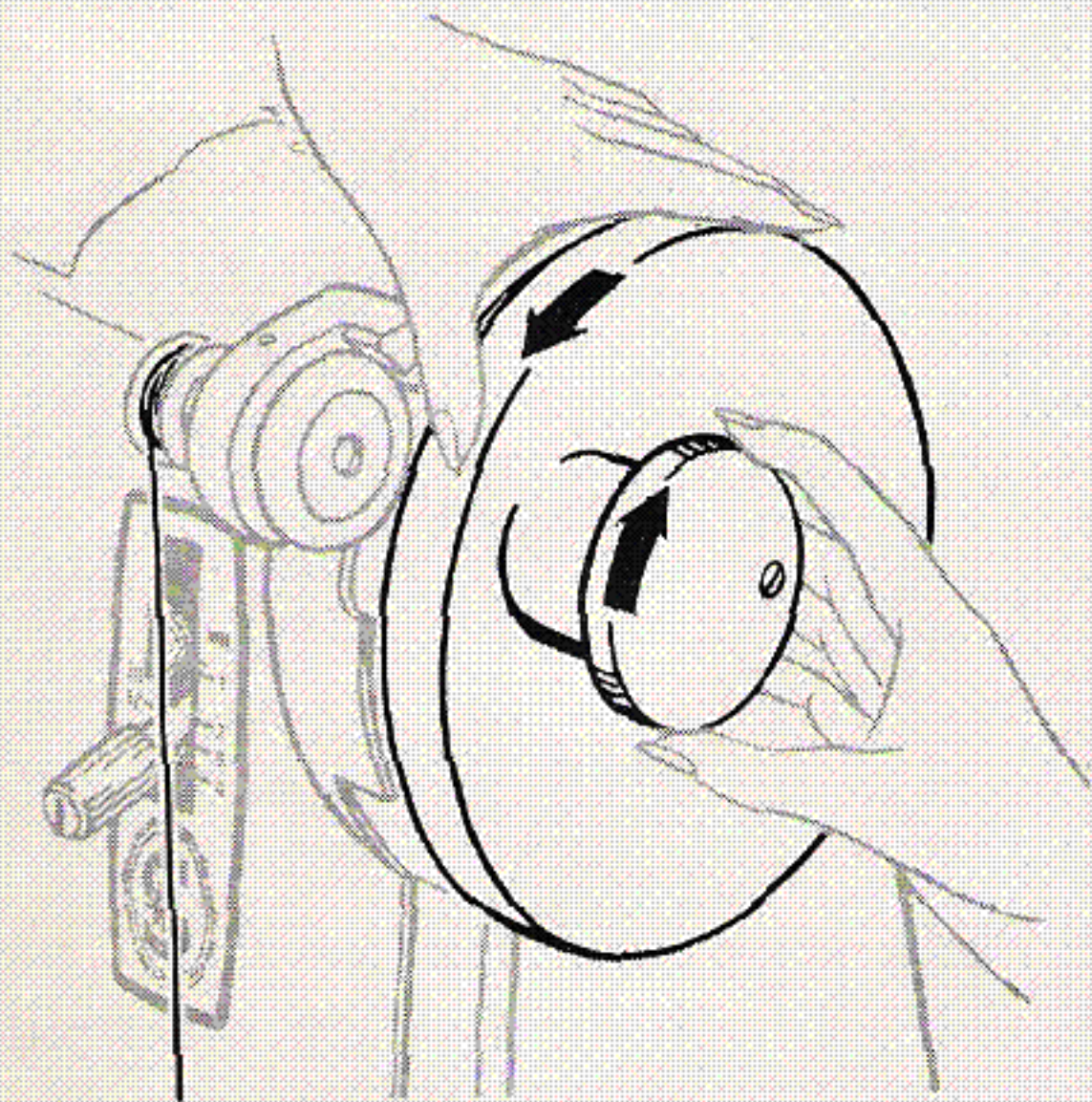

- Stop machine.
- Lift bobbin winder away from hand wheel and remove bobbin.
- Tighten stop motion screw.

*If thread doesn't wind evenly*

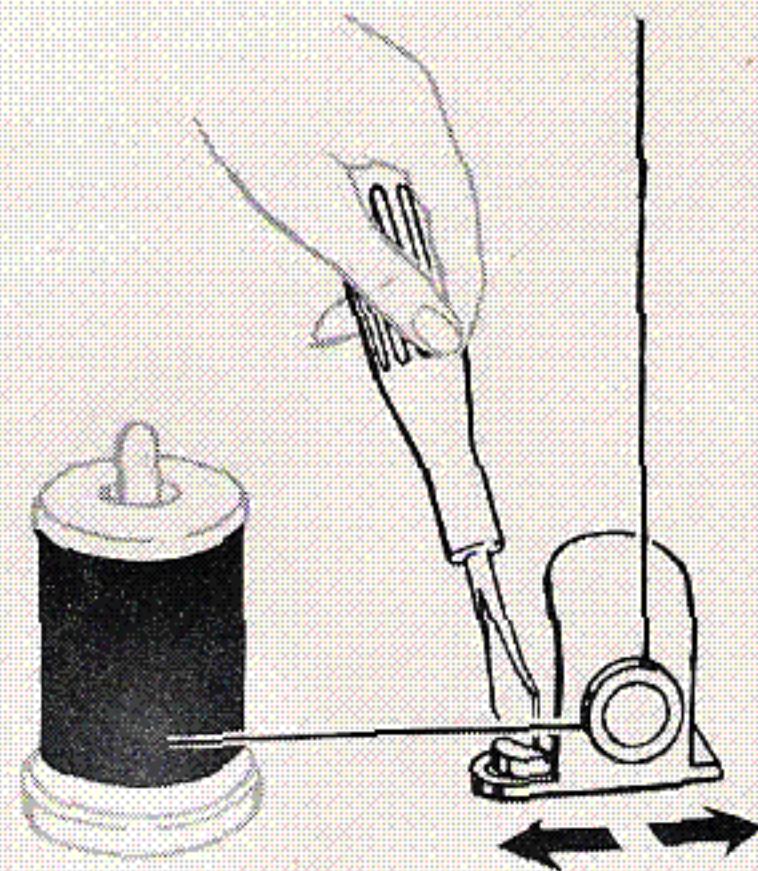

- Loosen screw which holds bobbin winder tension bracket to machine bed.
- Move bracket to left if bobbin winds high on right; move to right if bobbin winds high on left.
- Tighten tension bracket screw.

## THREADING THE BOBBIN CASE

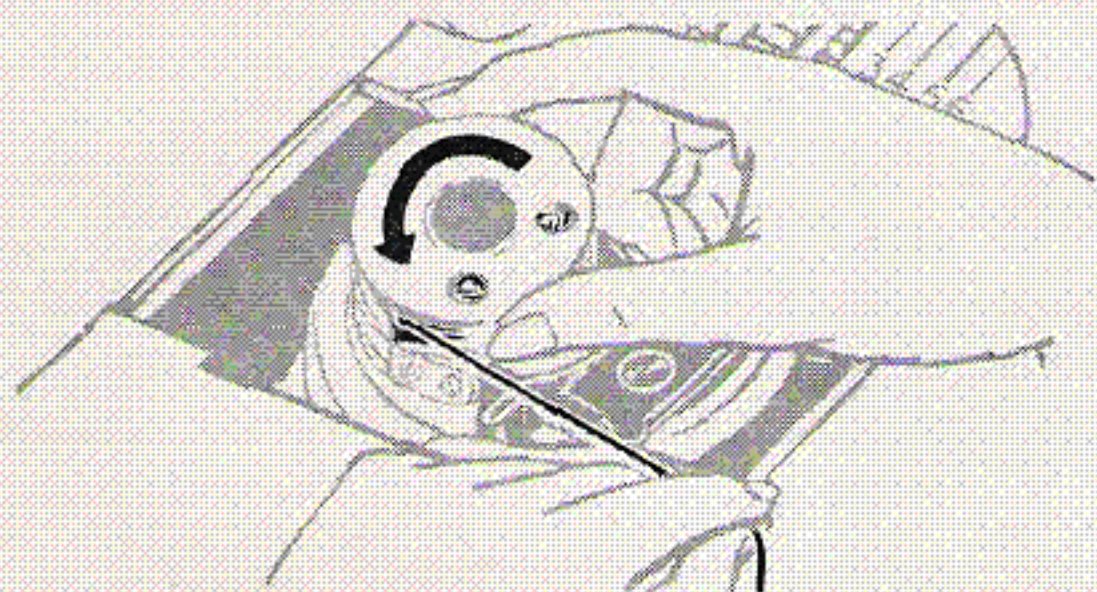

- Hold bobbin so that thread leads off in direction shown.

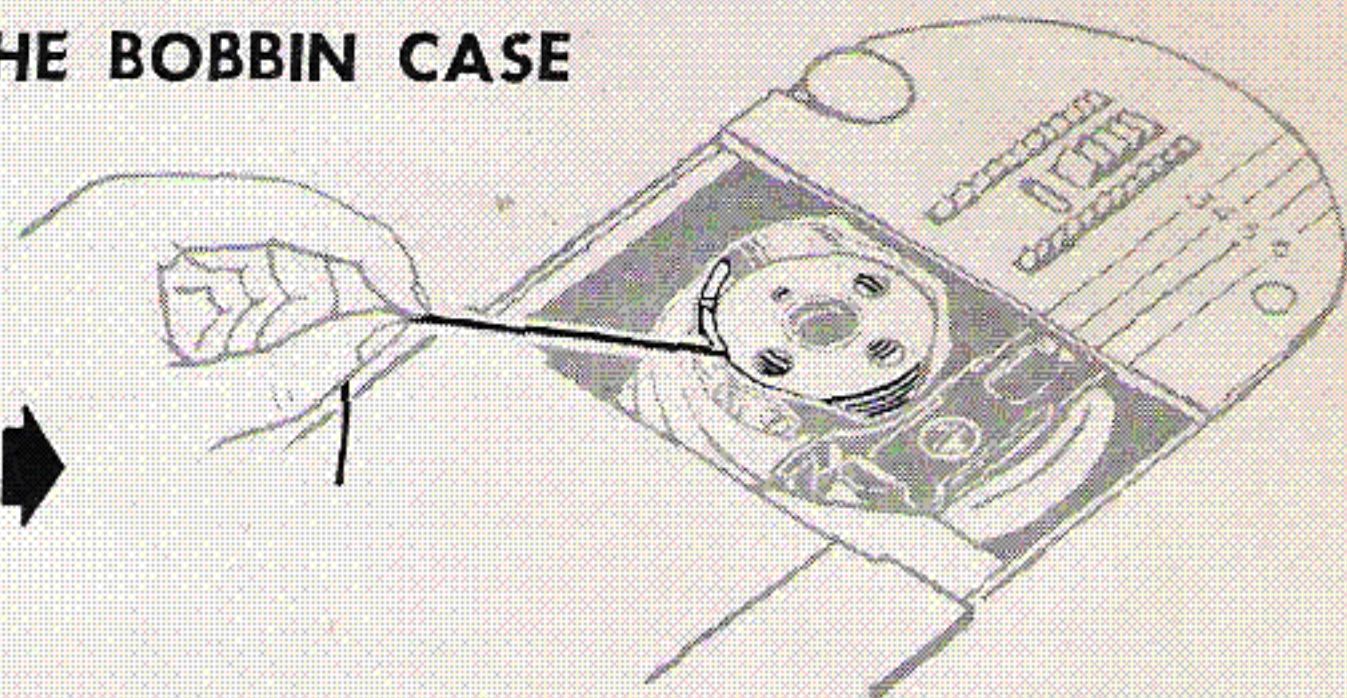

- Place bobbin in case.
- Lead thread into slot and under spring.

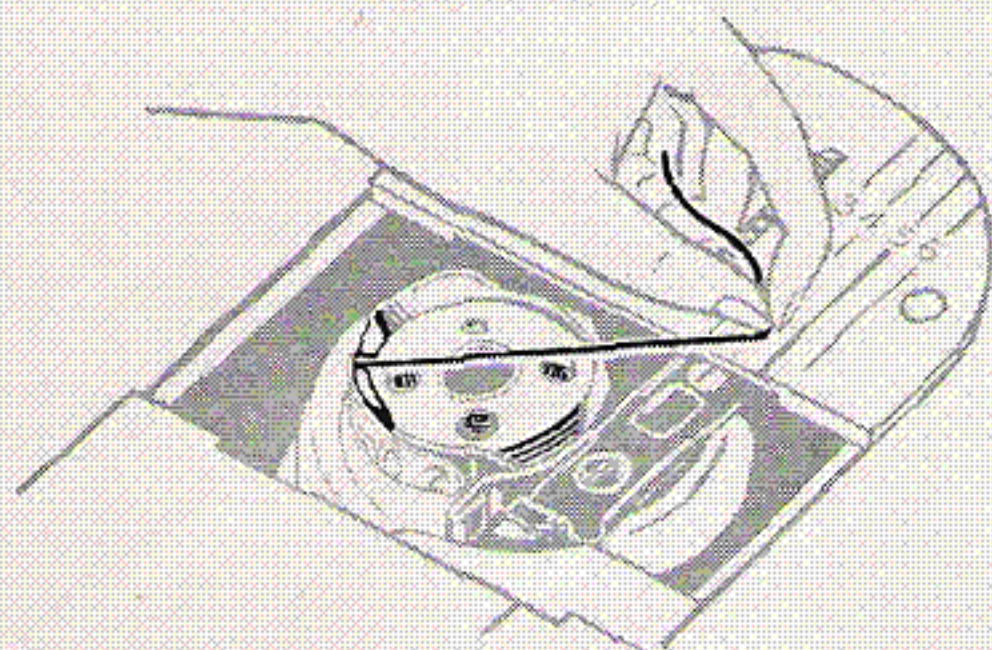

- Draw thread into notch at end of spring; pull about 3 inches of thread across bobbin.

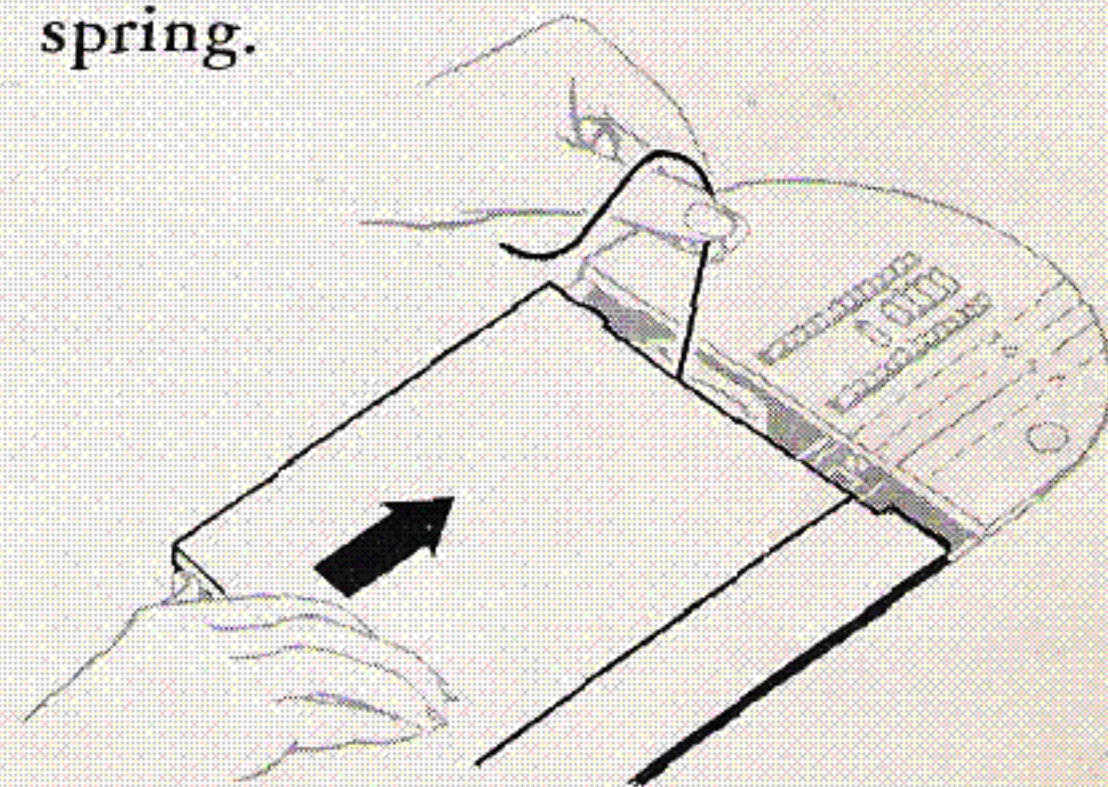

- Close slide plate.

## UPPER THREADING — ONE NEEDLE

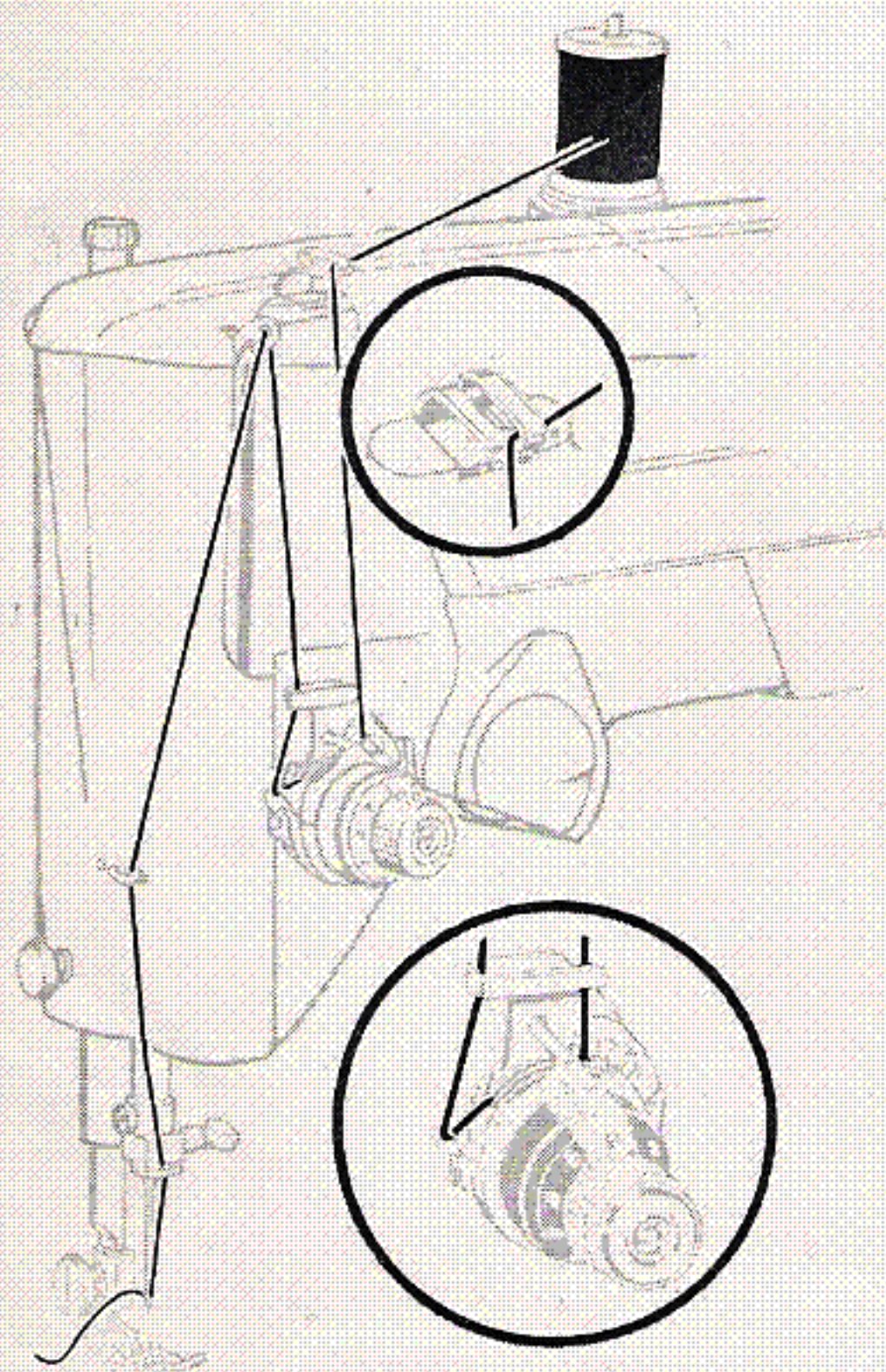

- Raise take-up lever to highest point.
- Lead thread through threading points shown.
- Draw sufficient thread through eye of needle with which to start sewing.

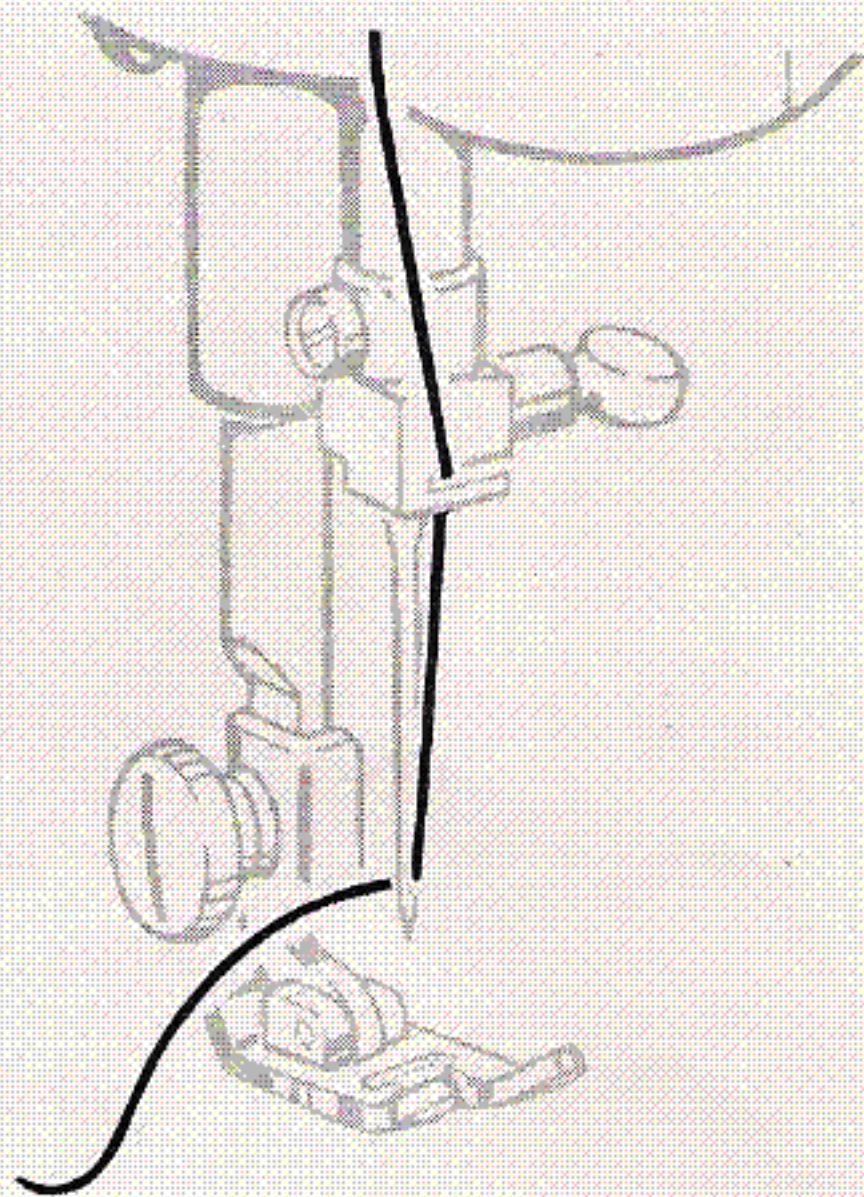

## STITCH LENGTH REGULATOR

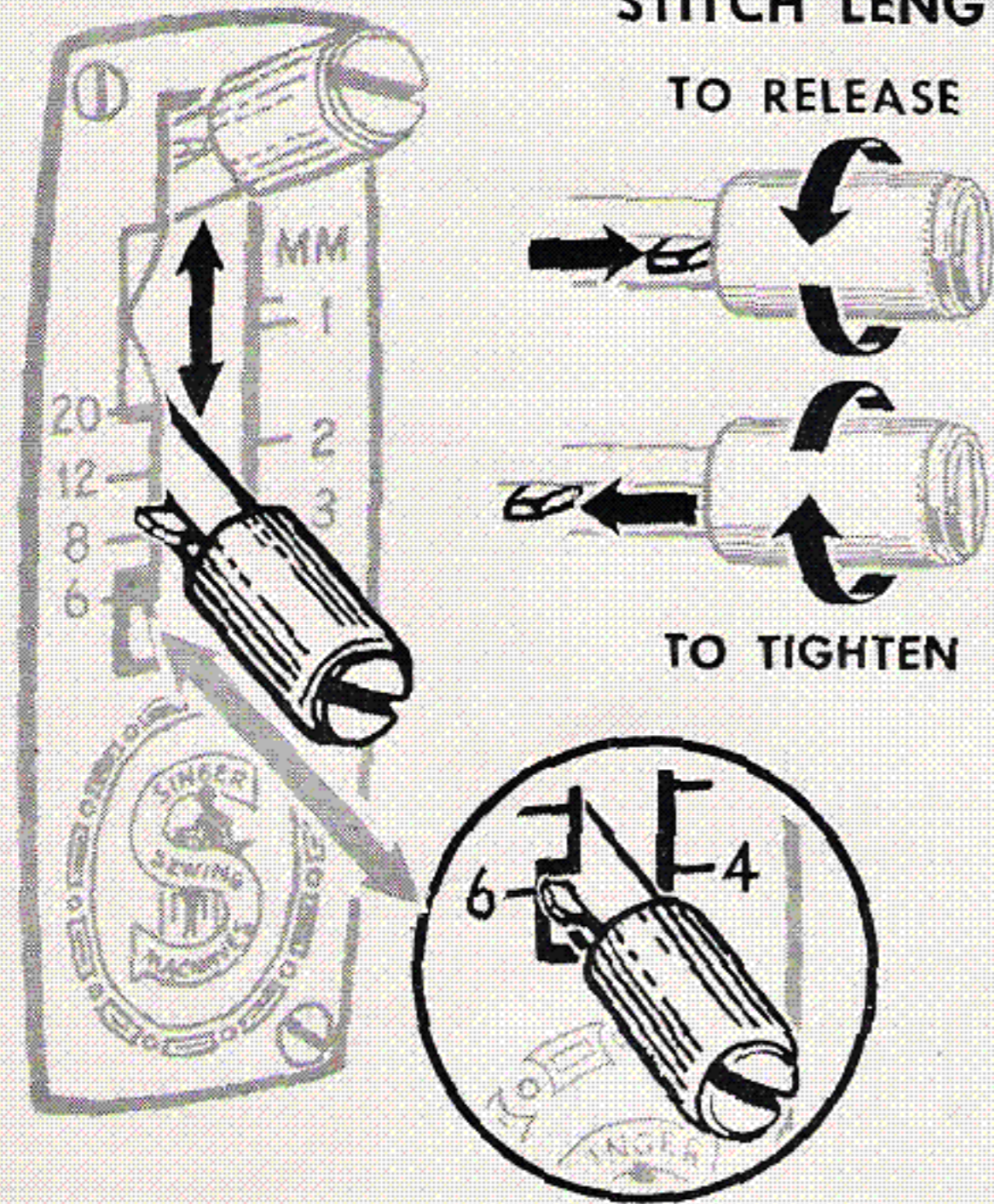

Numerals on left side of indicator represent number of stitches per inch. Numerals on right side represent stitch length in millimeters.

Upper inclined area of the regulator represents stitch lengths above 20.

Lower inclined area of the regulator allows the #6 stitch length setting to be "locked" in place when stitching folds, pleats or multiple layers of heavy fabric.

### To set stitch length

- Release pointer by turning thumb nut to the left.
- Position lever for desired stitch length.
- Tighten pointer against plate by turning thumb nut to the right.

Once the pointer has been positioned, reverse stitching is accomplished by raising the lever to its highest point. The #6 "locked" position must be unlocked for reverse stitching.

## THROAT PLATE

### Removal and Replacement

*To remove the throat plate*

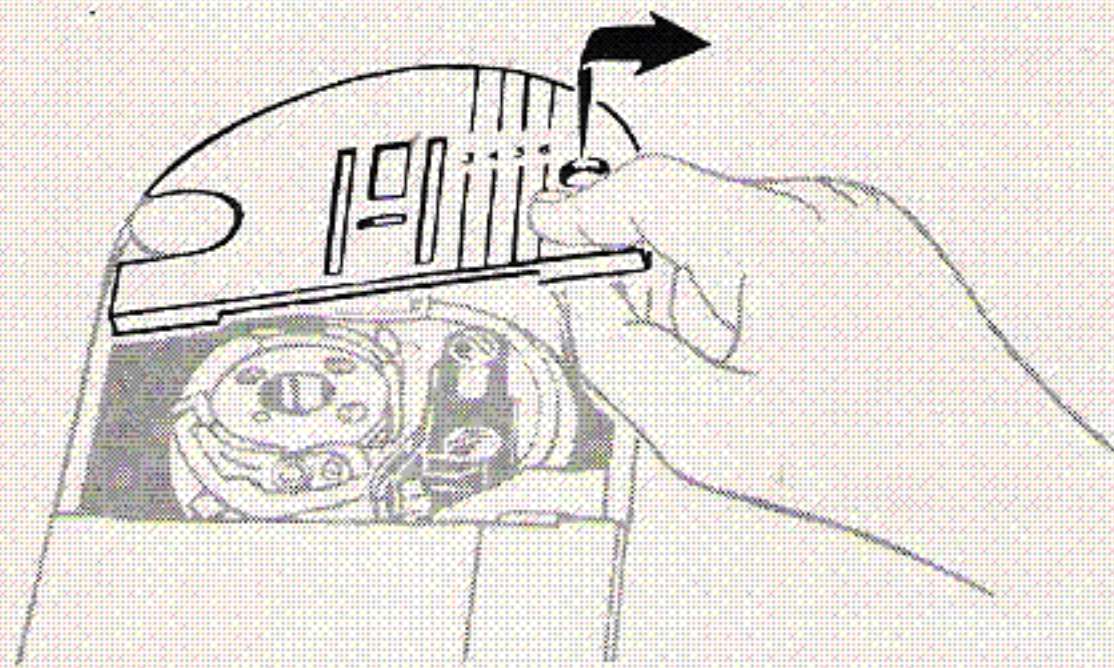

*To replace the throat plate*

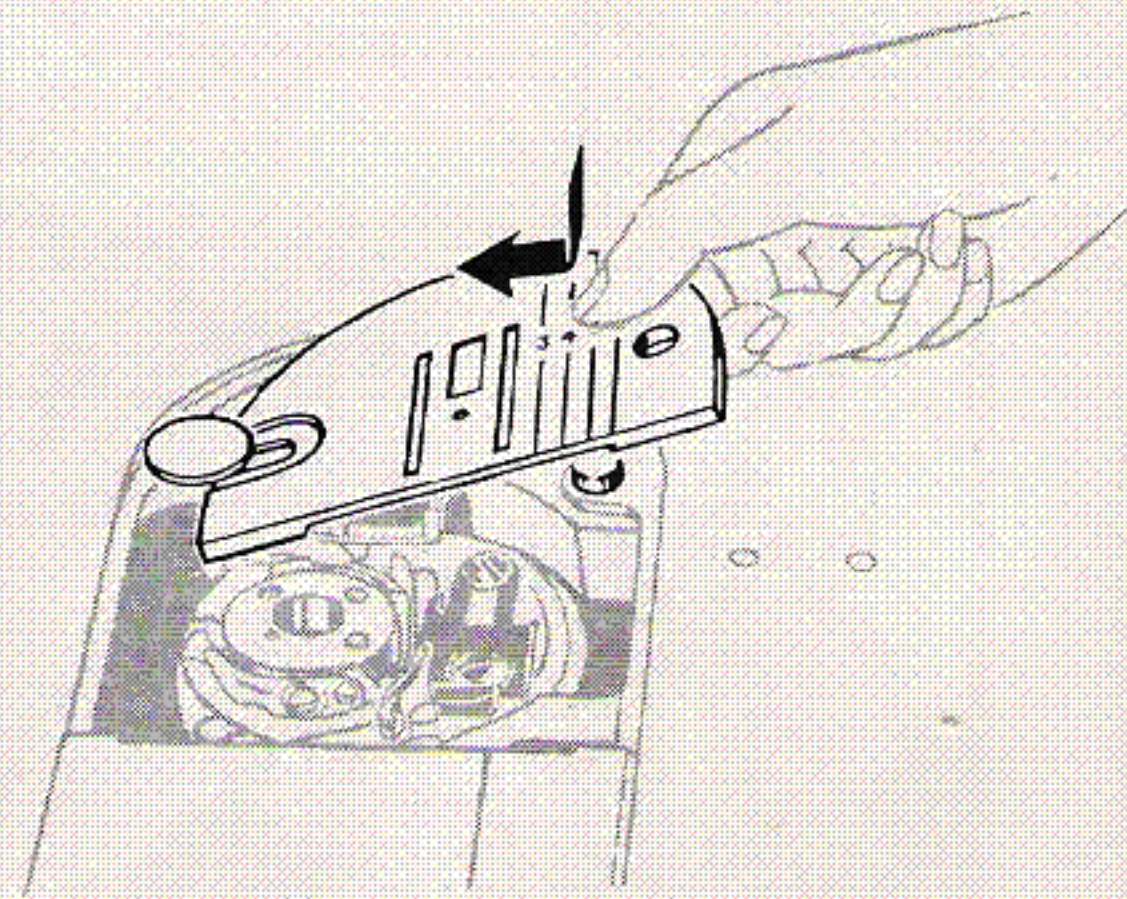

- Raise needle bar and presser foot.
- Open slide plate.
- Place thumb under right front end of throat plate and raise until clamping pin lifts up.
- Draw plate toward right to disengage.

- Position fork of plate under clamping pin as shown above.
- Push to left and press down until plate snaps into position.
- Close slide plate.

## STITCH CONTROLS

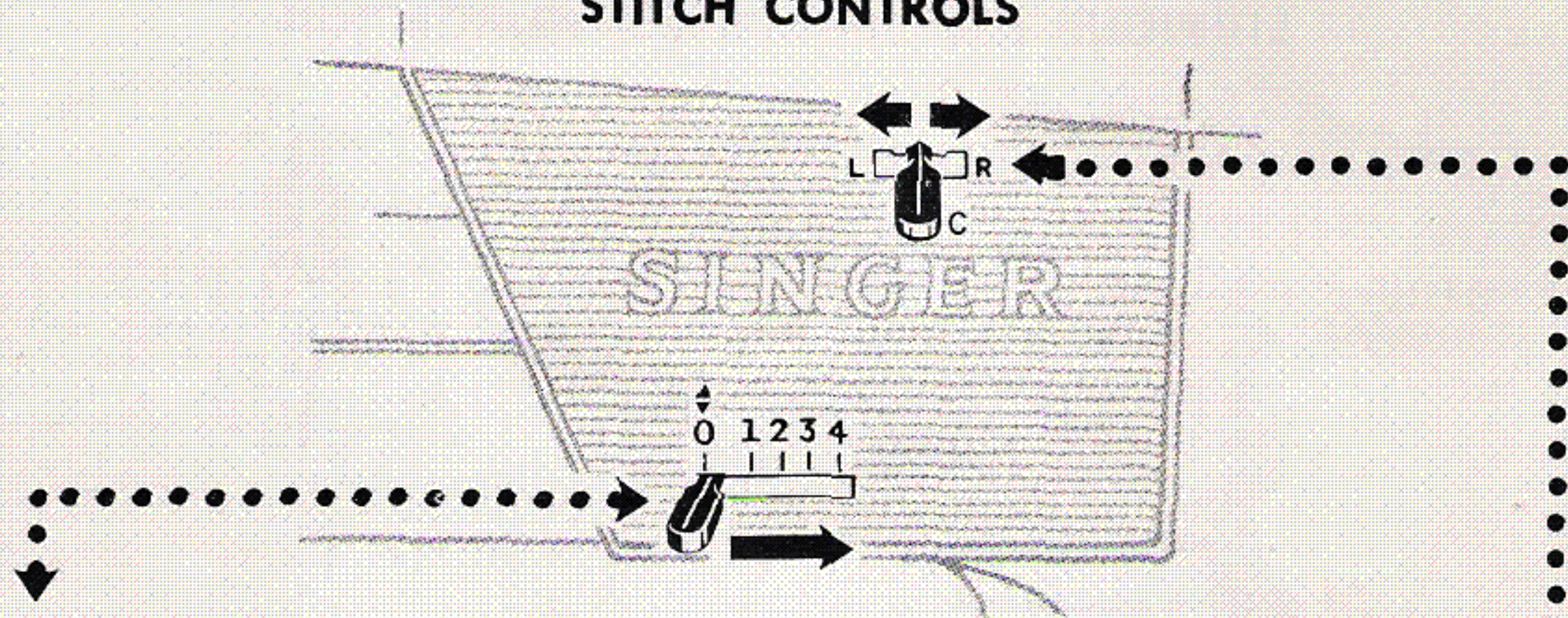

### Stitch Width Selector

Selector lever regulates swing of needle from its straight stitching position 0 to maximum width 4 (5/32 inch).

To position, slide lever to desired setting. Numerals indicate four width settings, but intermediate settings may also be used.

Do not make any stitch width or needle position adjustments while the needle is in the fabric.

### Needle Position Selector

Left (L), Center (C) and Right (R) needle position settings are available for placement of both straight and zigzag stitching.

To position, slide lever to desired setting.

## STRAIGHT STITCHING — CENTER POSITION

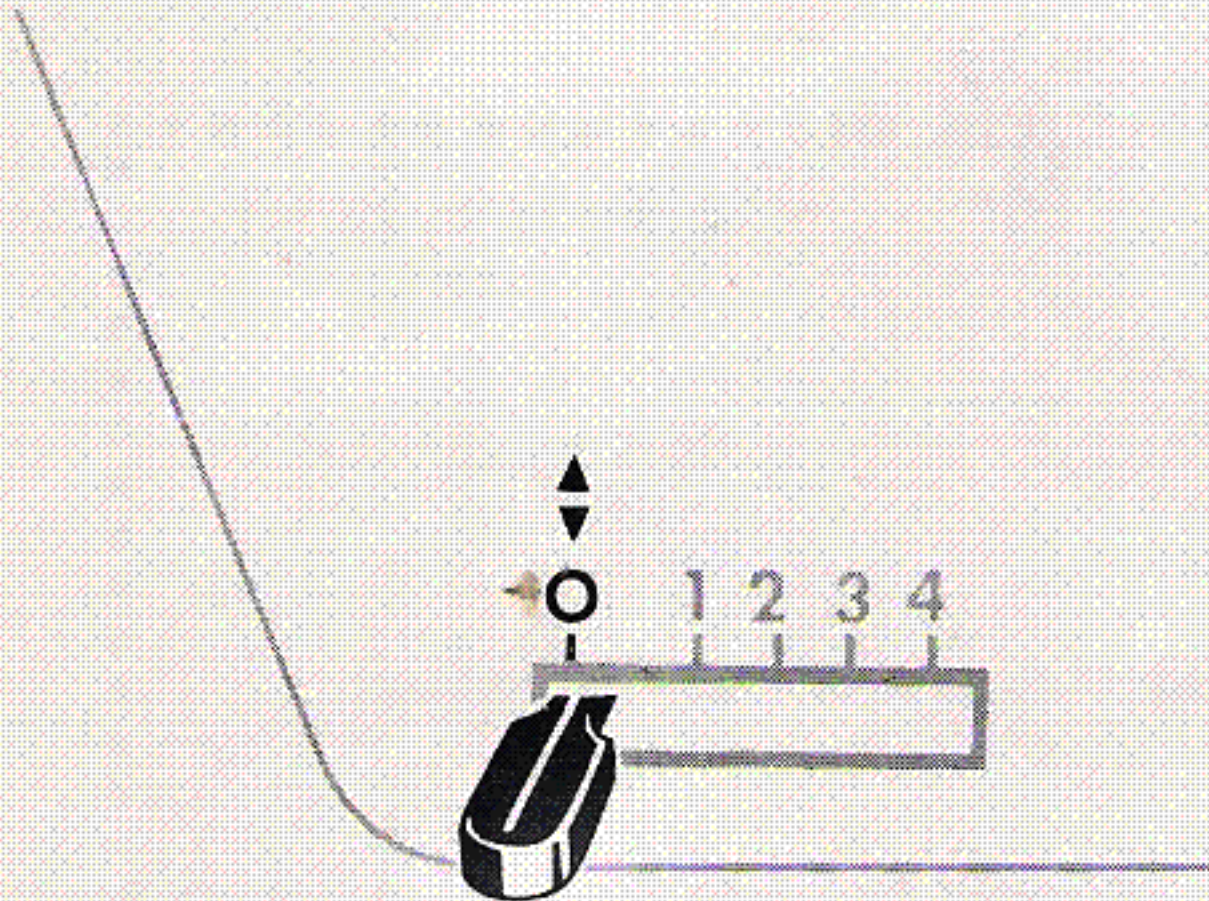
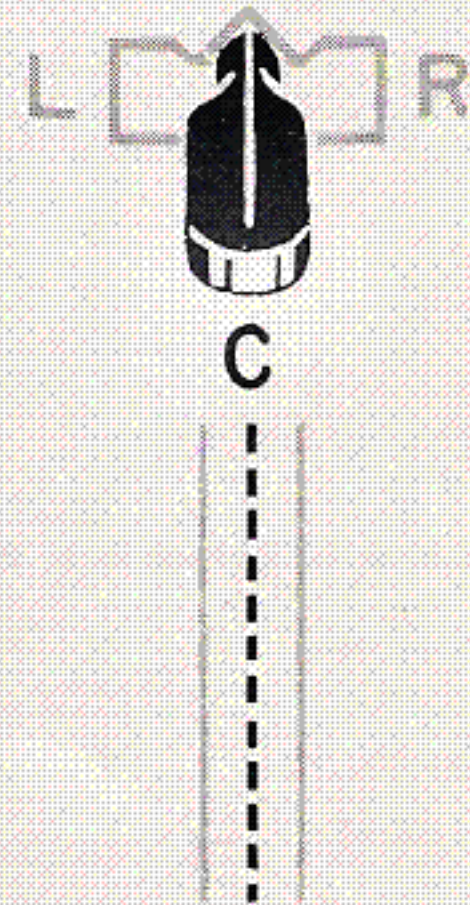
STITCH WIDTH SELECTOR: **0**NEEDLE POSITION SELECTOR: **C**

The general purpose throat plate and presser foot as well as the straight stitch throat plate and presser foot can be used in **C** needle position.



## STRAIGHT STITCHING EQUIPMENT

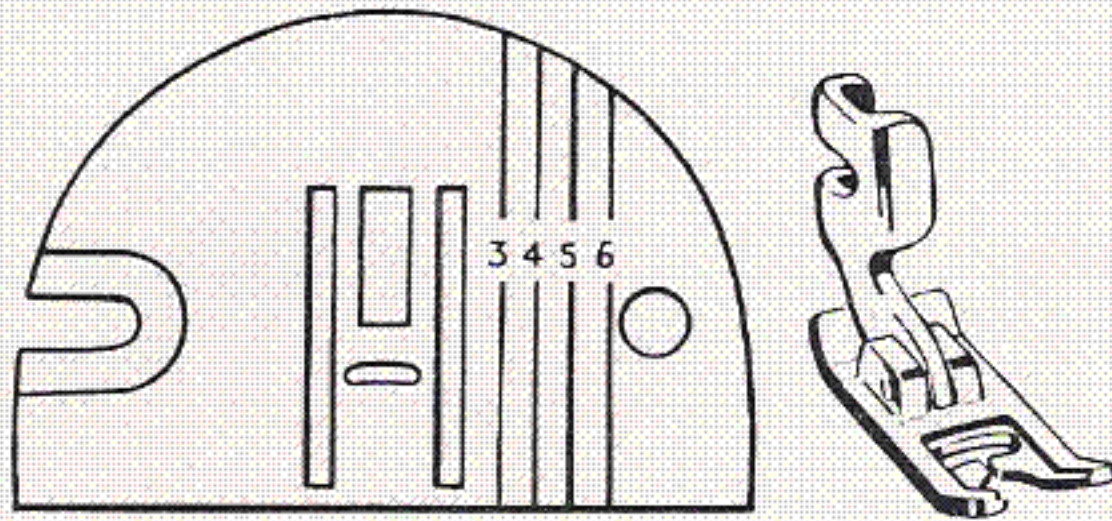

GENERAL PURPOSE THROAT PLATE  
GENERAL PURPOSE PRESSER FOOT

GENERAL PURPOSE THROAT PLATE AND PRESSER FOOT are used for all utility sewing and where there is occasion to alternate between straight and zigzag stitching in the sewing procedure.

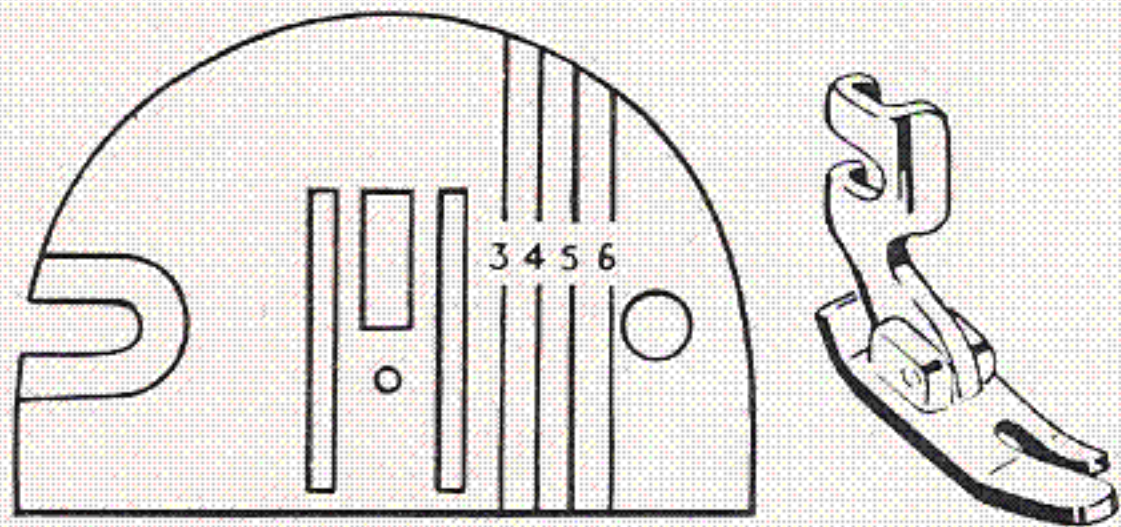

STRAIGHT STITCH THROAT PLATE  
STRAIGHT STITCH PRESSER FOOT

STRAIGHT STITCH THROAT PLATE AND PRESSER FOOT are used where fabric and sewing procedure require close control . . . for the precision stitching of curved and scalloped edges, top stitching, edge stitching, etc. This equipment should be used when stitching delicate or spongy fabrics, synthetics, and knits.

## STRAIGHT STITCHING — SECONDARY POSITIONS

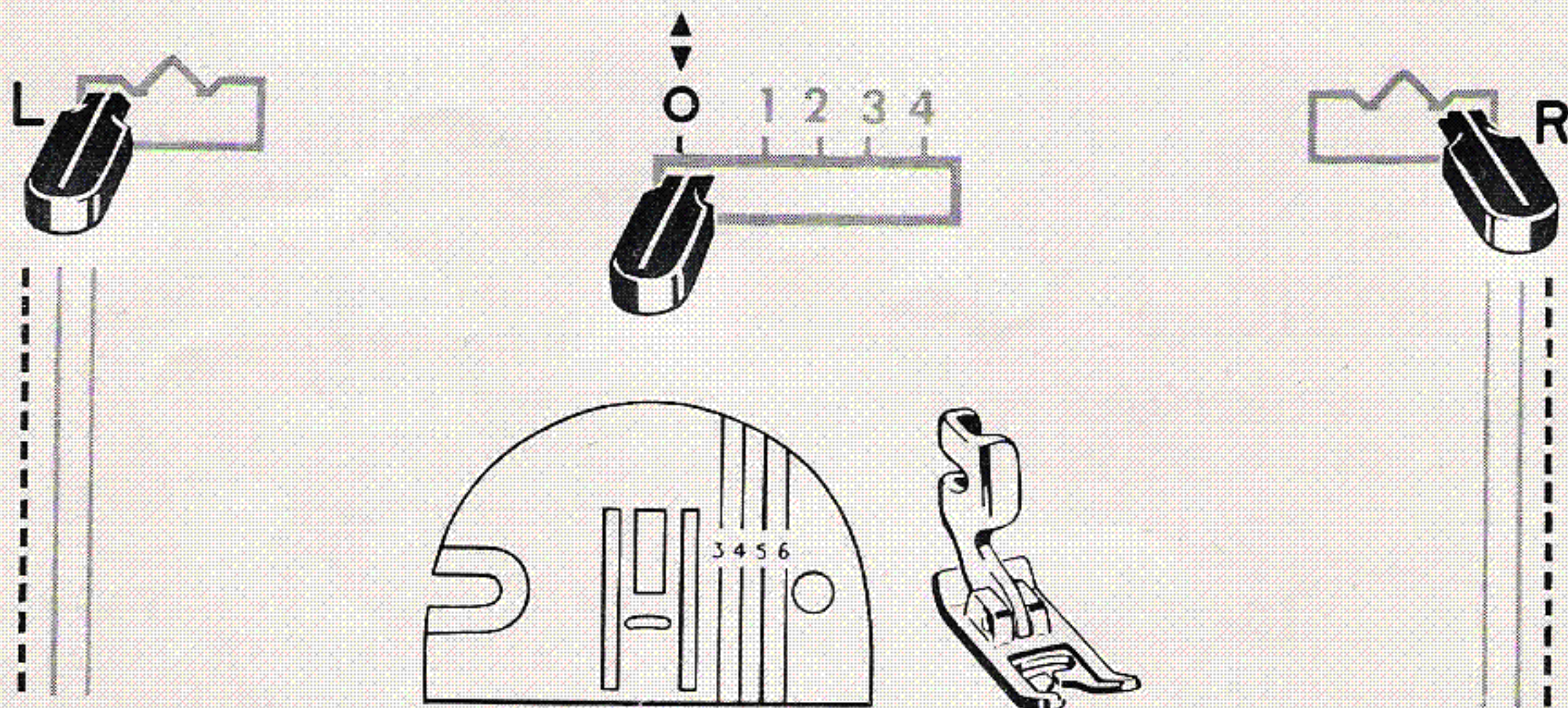

STITCH WIDTH SELECTOR: ○

NEEDLE POSITION SELECTOR: L OR R

GENERAL PURPOSE THROAT PLATE AND PRESSER FOOT

To meet special requirements a line of stitching may be placed to right or left of center. The general purpose throat plate and presser foot *must* be used with secondary needle positions.

## PREPARING TO SEW

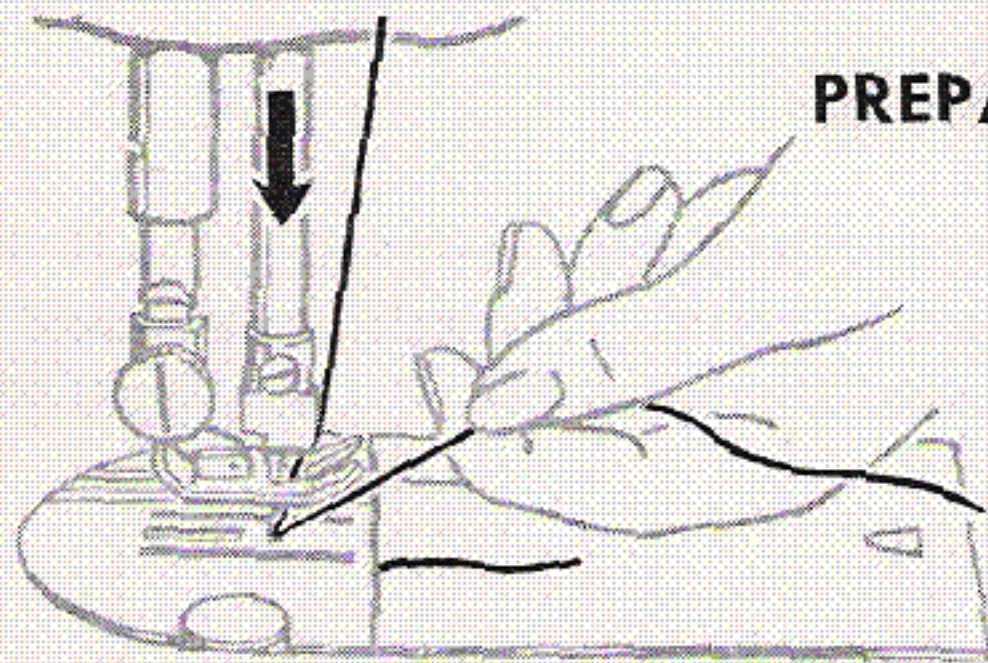

- Hold needle thread lightly with left hand.

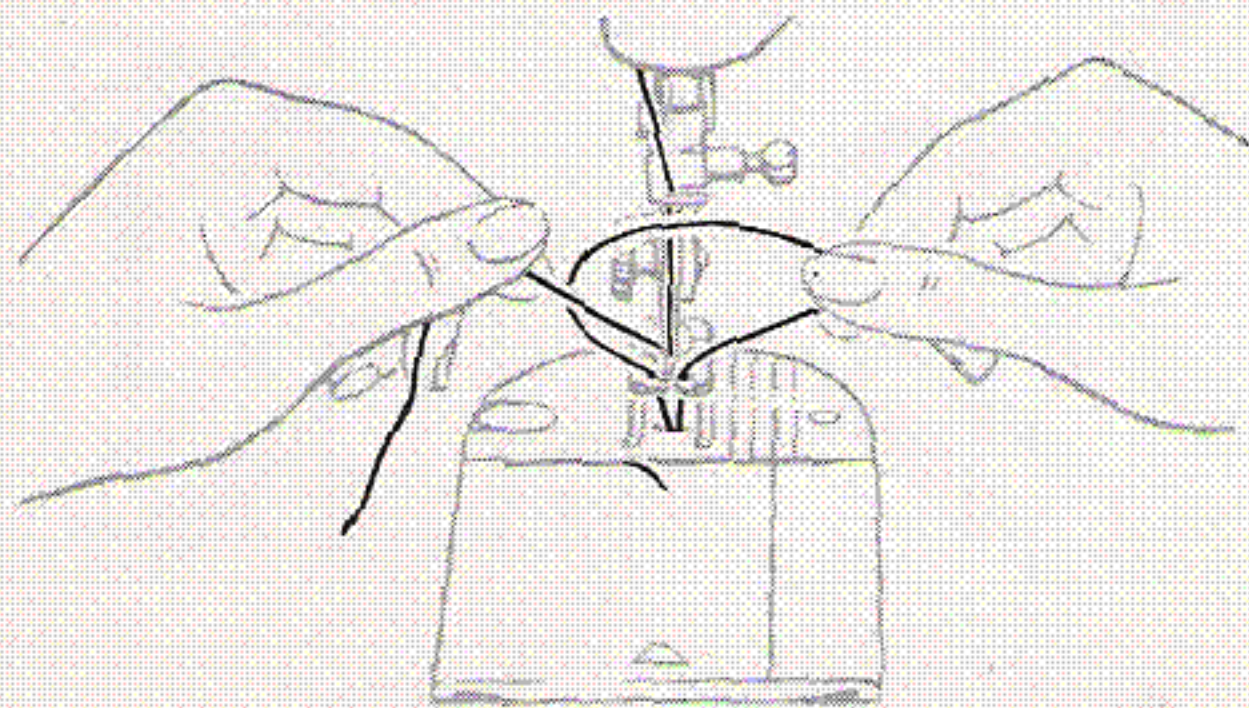

- Pull end of bobbin thread up through throat plate.

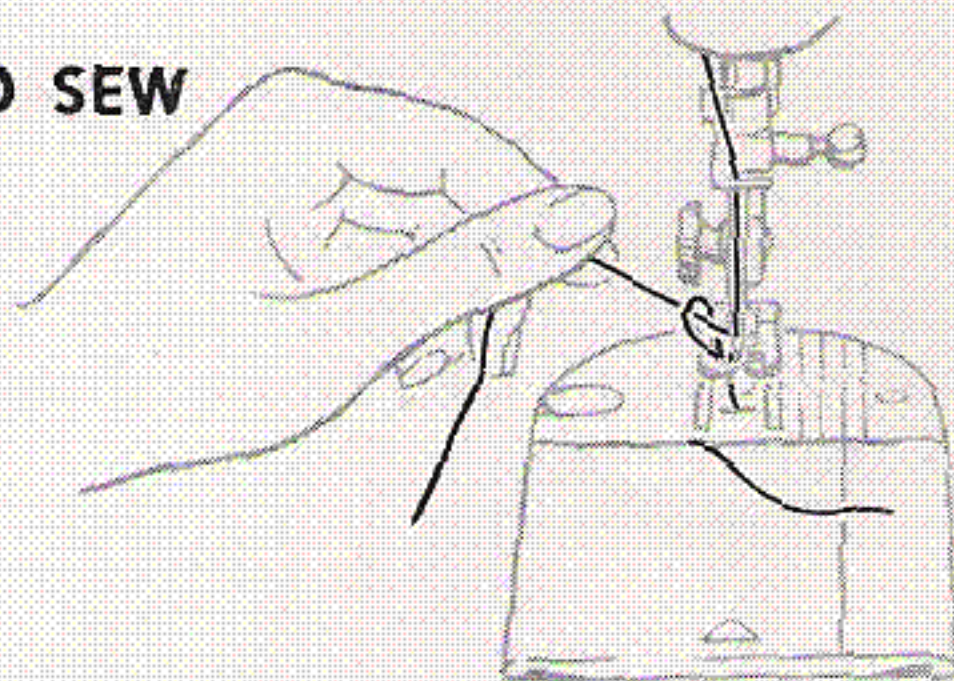

- Turn hand wheel so that needle enters plate and brings up bobbin thread.

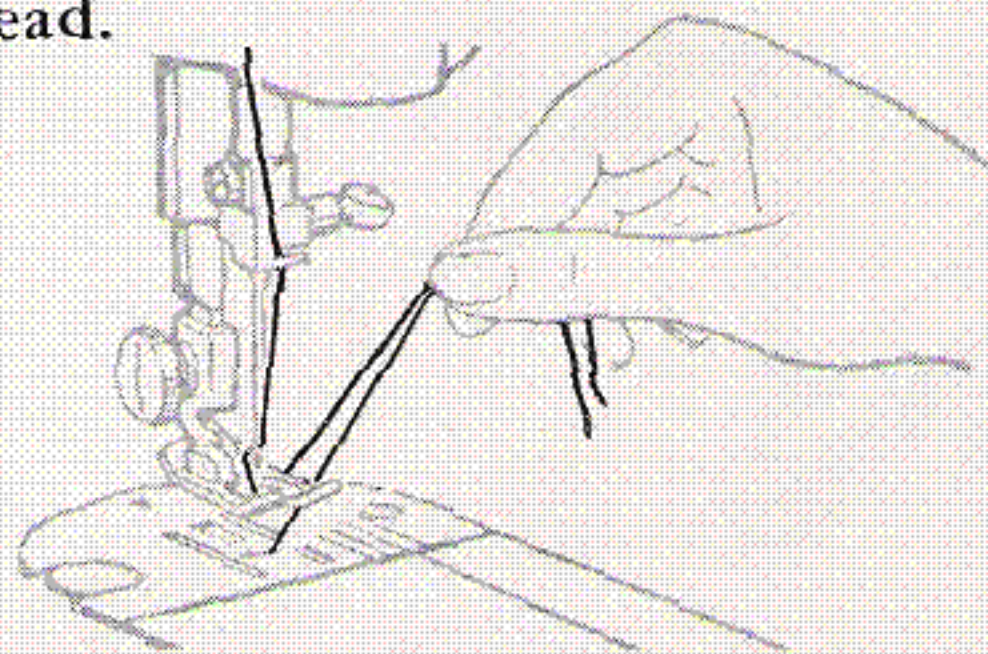

- Place both needle and bobbin threads diagonally under presser foot.

## SEWING A SEAM

- Set stitch regulator for desired stitch length.
- Position needle into fabric about  $\frac{1}{2}$  inch from edge.
- Lower presser foot.
- Raise stitch length regulator to reverse.

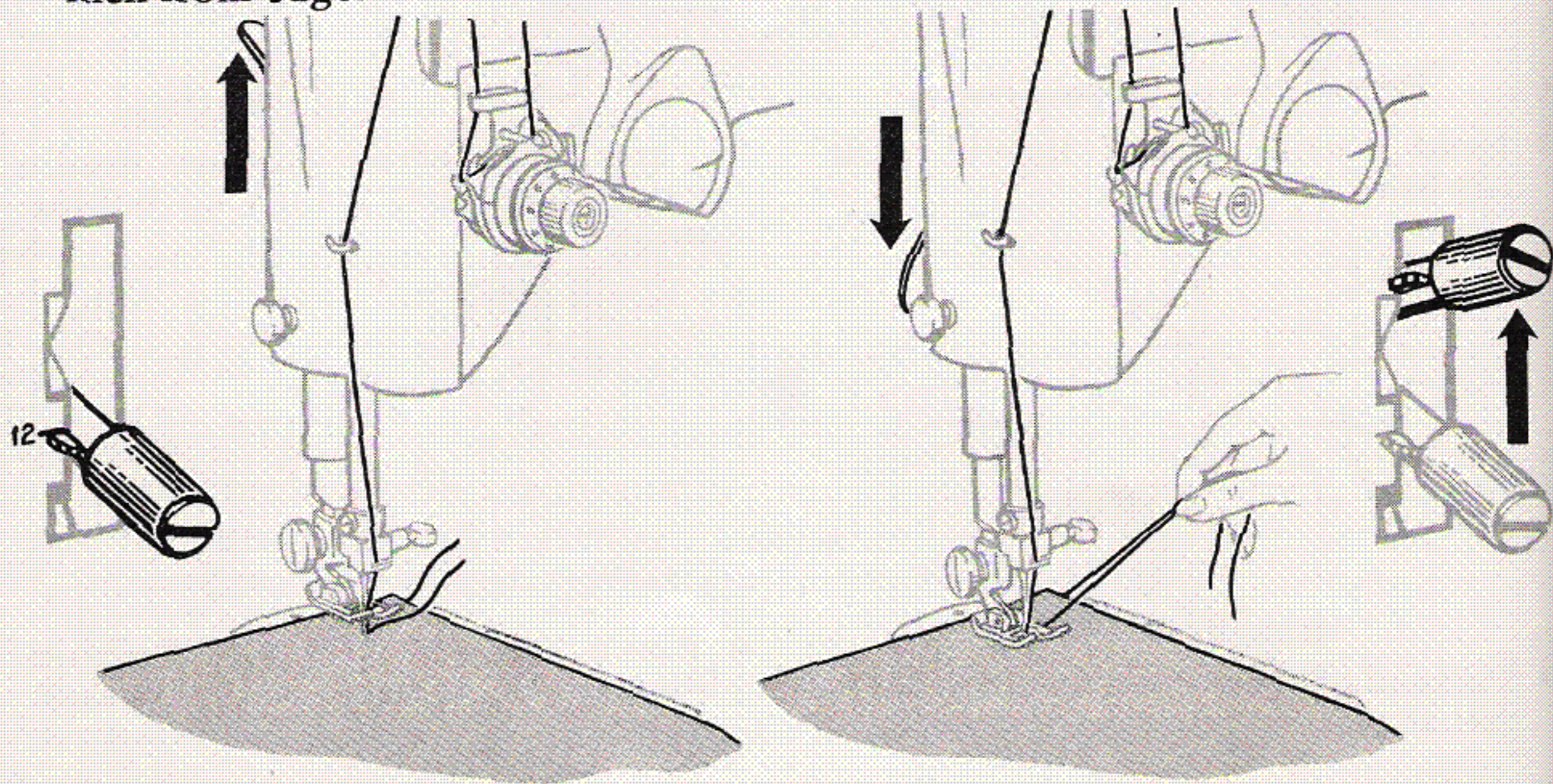

## SEWING A SEAM (Cont'd)

- Back stitch to edge of fabric for reinforcement.
- Lower stitch length regulator.
- Stitch to end of seam.
- Raise stitch length regulator.

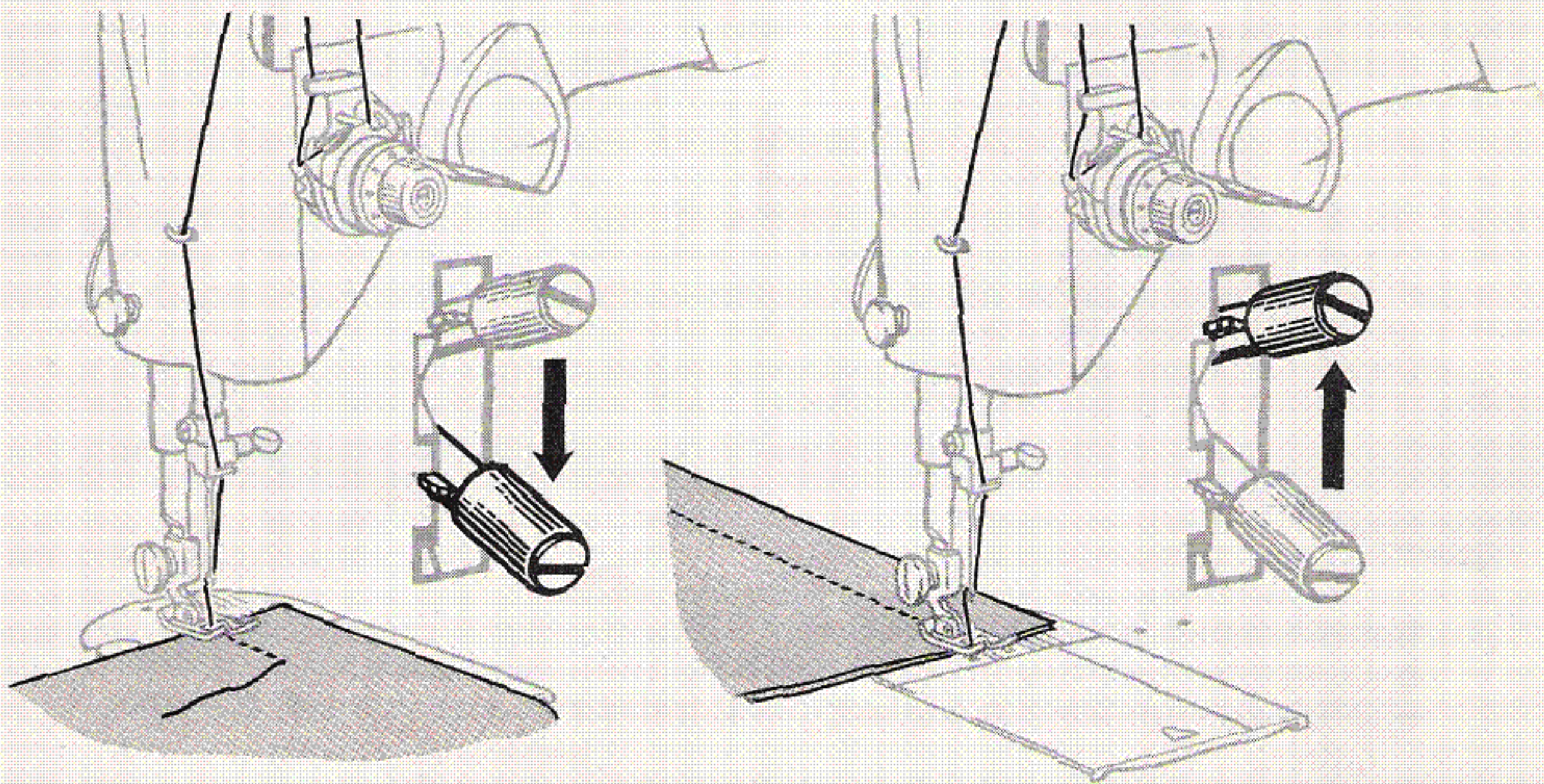

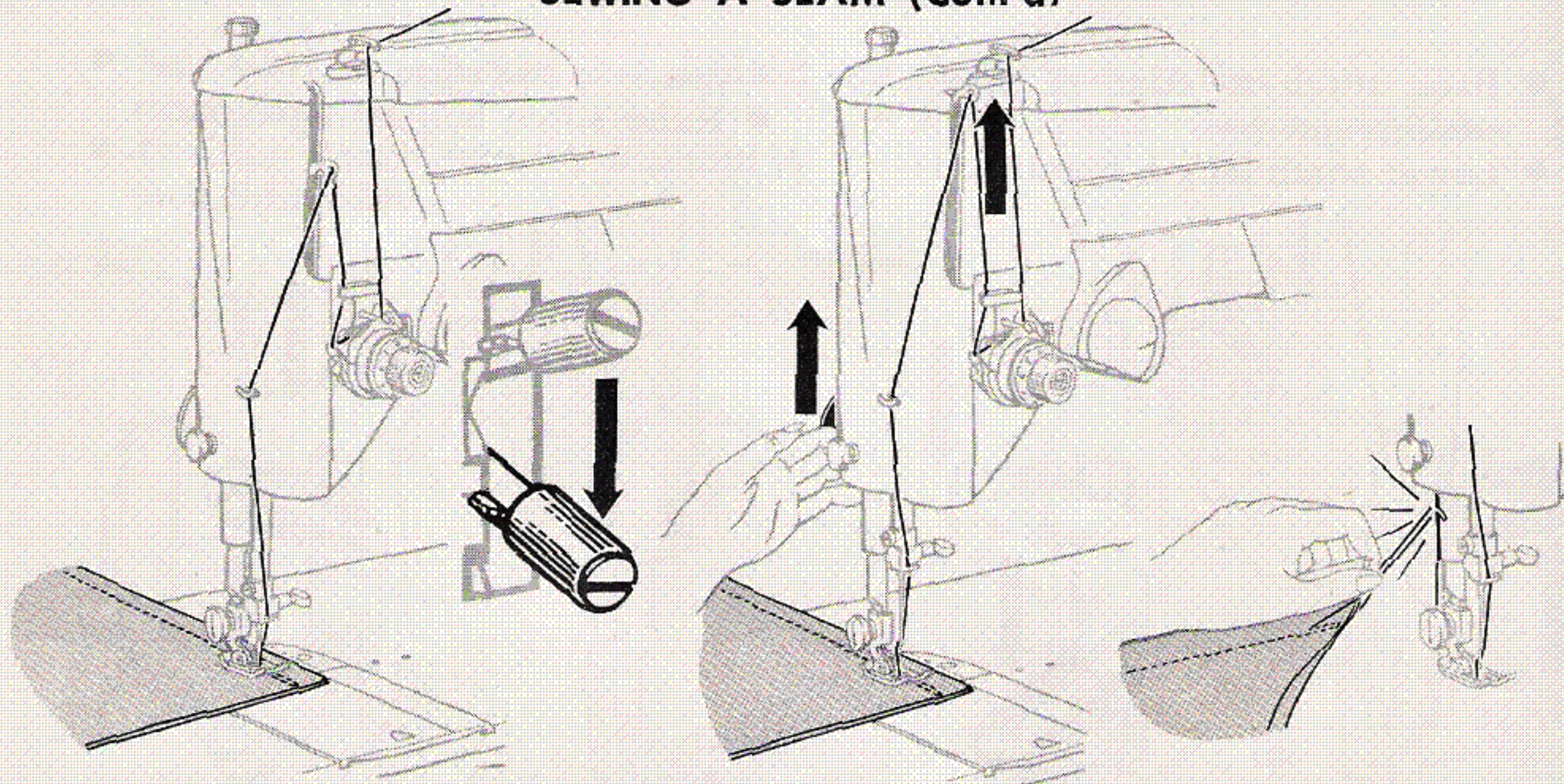
**SEWING A SEAM (Cont'd)**

- Back stitch to reinforce end of seam.
- Lower regulator to forward stitching position.
- With take-up lever at highest point, raise presser foot and remove fabric.

## GUIDING AND SUPPORTING FABRIC

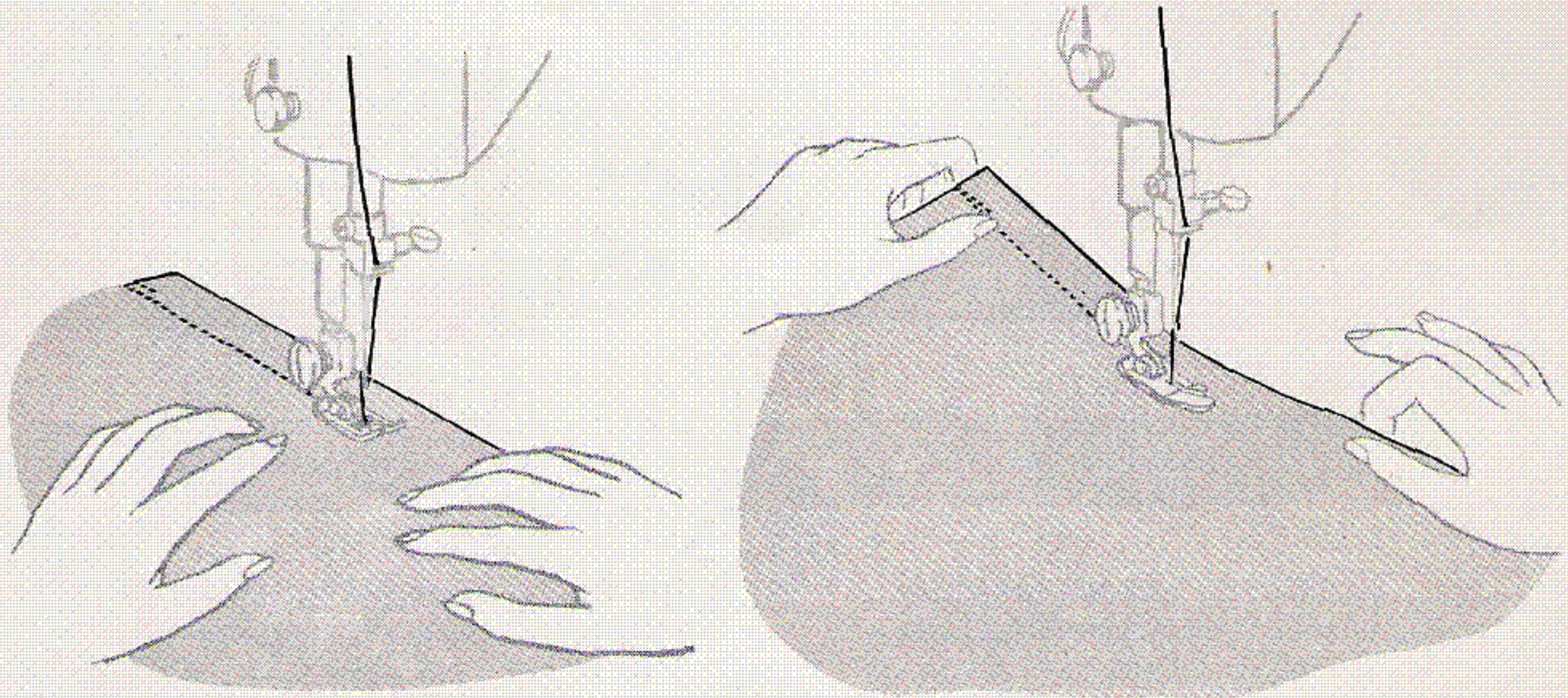

Most fabrics need to be guided only in front of the presser foot. Fabrics of unusual texture and weave, filmy sheers, crepes, knits, tricots, etc., require support while being stitched. For such fabrics apply a gentle tension by holding seam in front and back of the presser foot as illustrated.

## NEEDLE THREAD TENSION

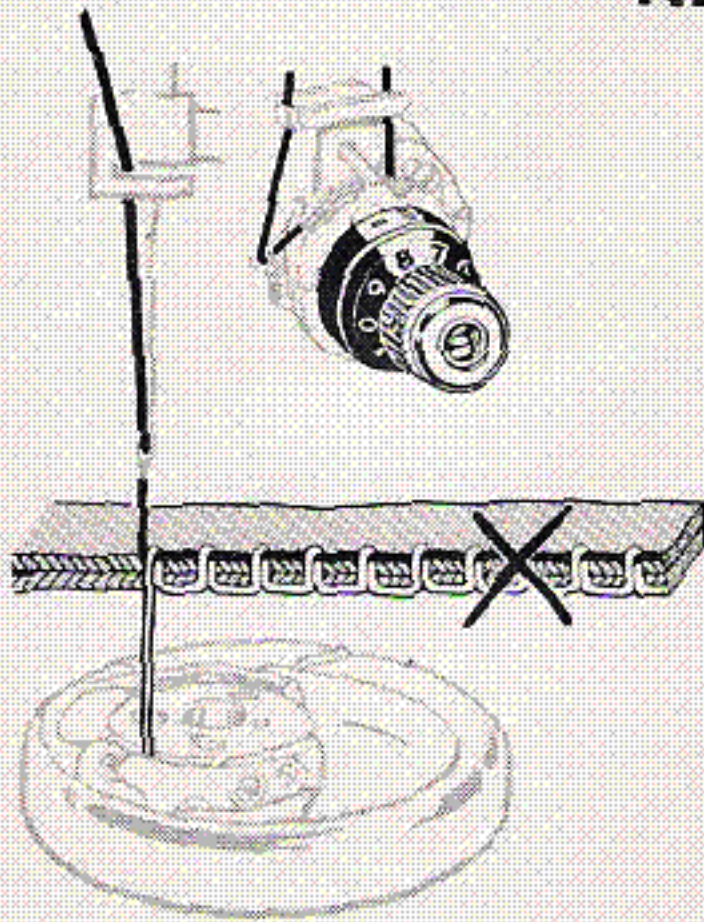

Needle thread tension too tight—correct by setting dial to lower number.

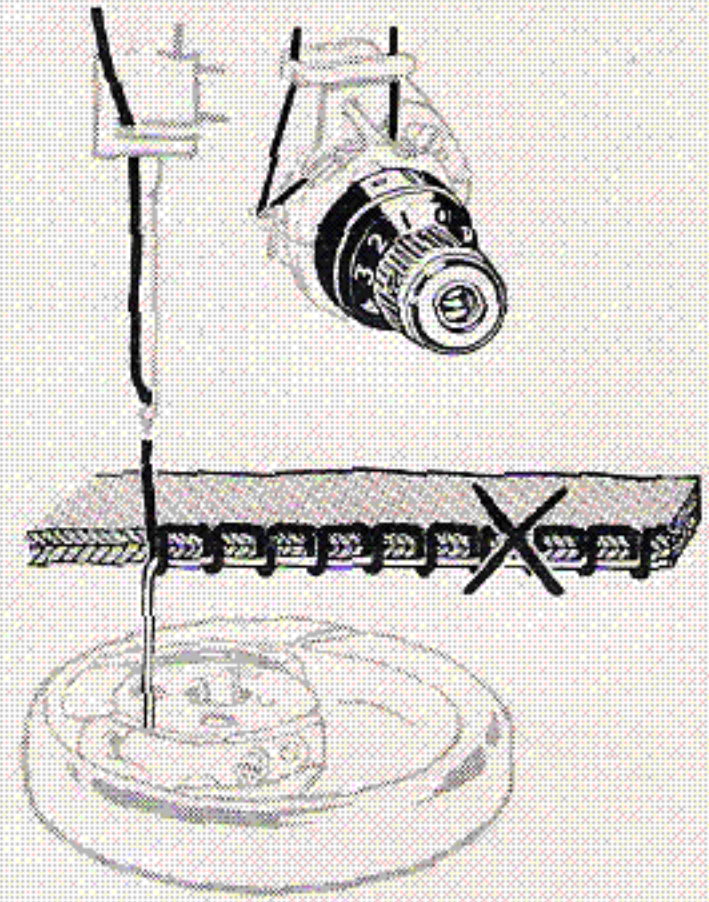
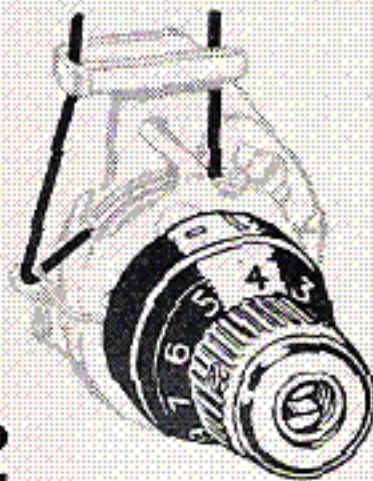

Needle thread tension too loose—correct by setting dial to higher number.



A perfectly locked stitch results with upper and lower tensions balanced so that needle and bobbin threads are drawn equally into fabric.



## BOBBIN THREAD TENSION

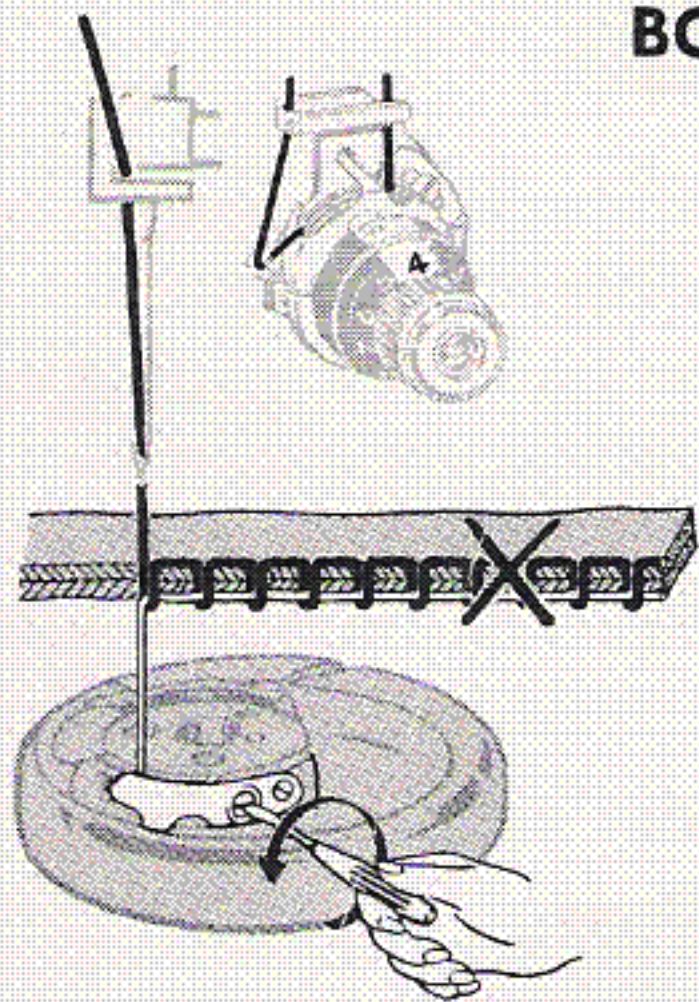

Bobbin thread tension too tight  
—correct by turning screw counterclockwise.

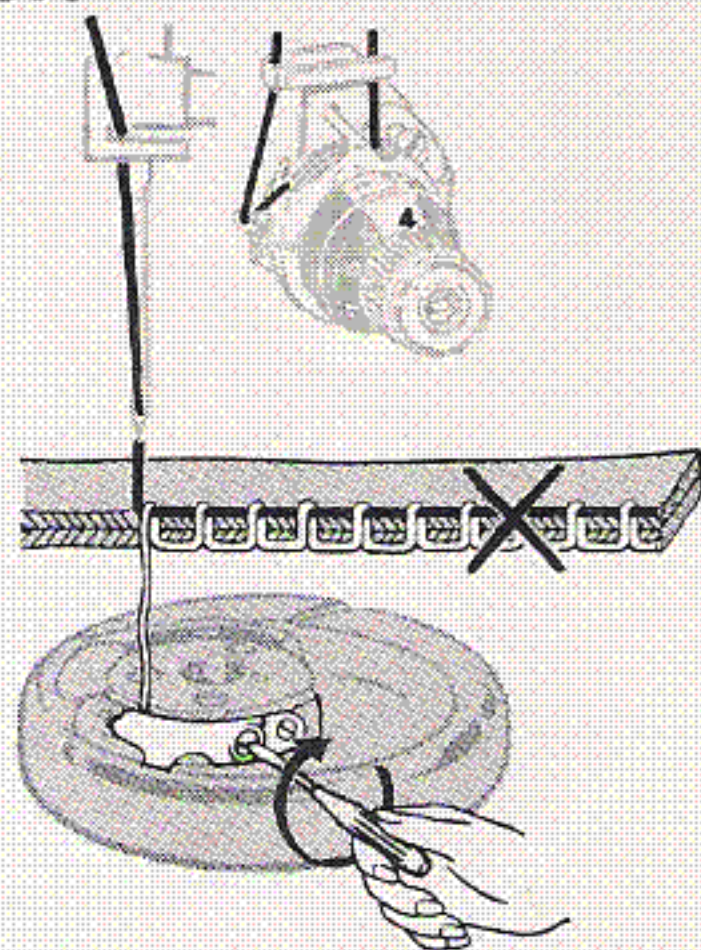

Bobbin thread tension too loose  
—correct by turning screw clockwise.



A perfectly locked stitch results with upper and lower tensions balanced so that needle and bobbin threads are drawn equally into fabric.

## PRESSURE ADJUSTMENTS

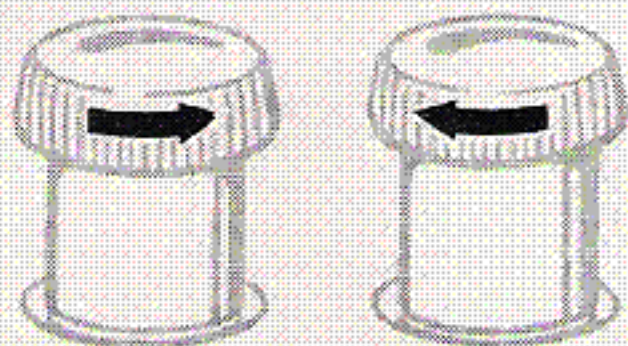

**Decrease      Increase**

- To decrease pressure, turn thumb screw upward.
- To increase pressure, turn thumb screw downward.

Smooth, even handling of several thicknesses of fabric results when pressure is correctly regulated.

Surface finish, as well as the weight and texture of the fabric, must be considered in determining the amount of pressure needed.

Adjustment of the thumb screw regulates the amount of pressure exerted on the material while it is being stitched.

Too light a pressure will result in irregular feeding which affects both quality of stitch and evenness of seams.

Too heavy a pressure not only affects stitch and seam quality but will mar smooth surfaces and pile fabrics.

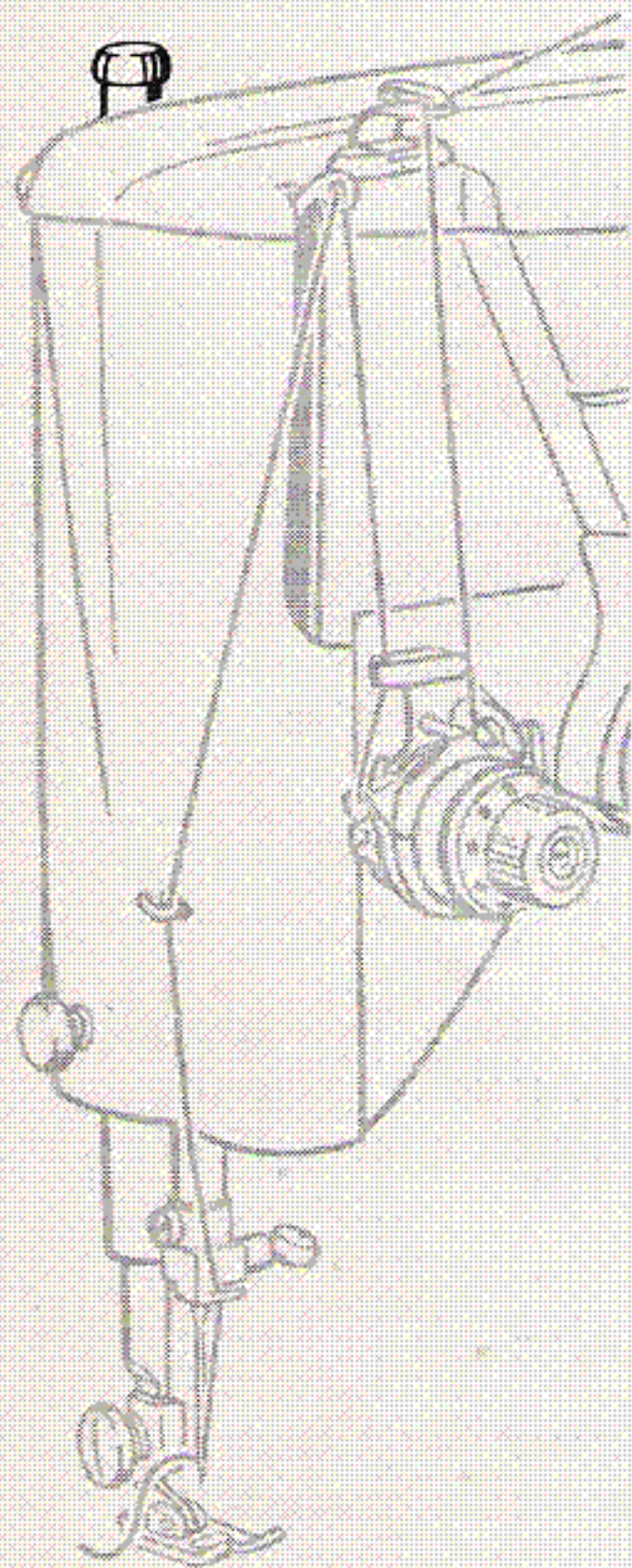

**ZIGZAG STITCHING EQUIPMENT**

GENERAL PURPOSE  
PRESSER FOOT

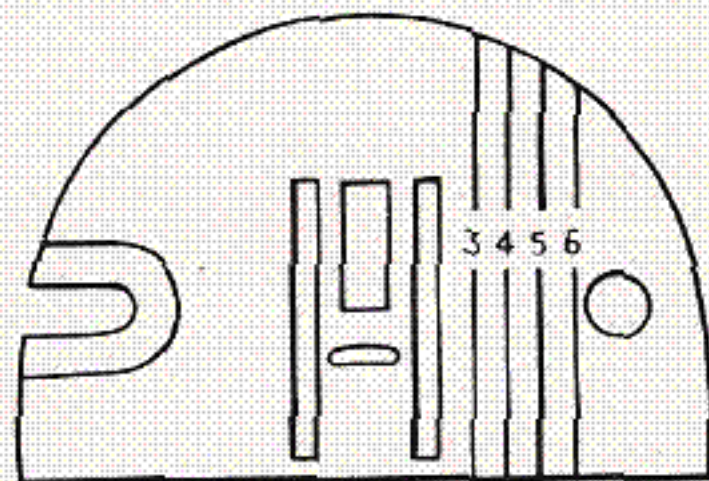

GENERAL PURPOSE  
THROAT PLATE

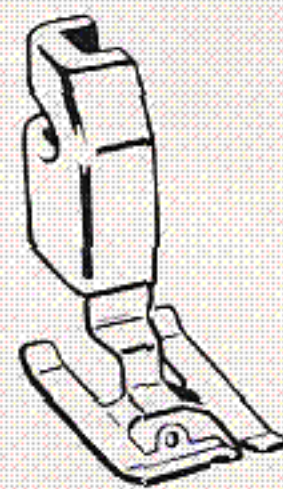

SPECIAL PURPOSE  
PRESSER FOOT

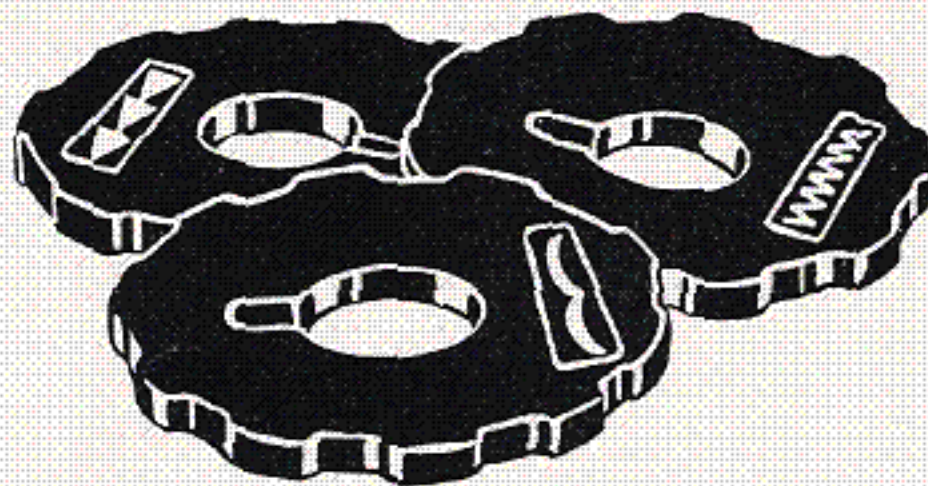

FASHION DISCS

## ZIGZAG STITCHING

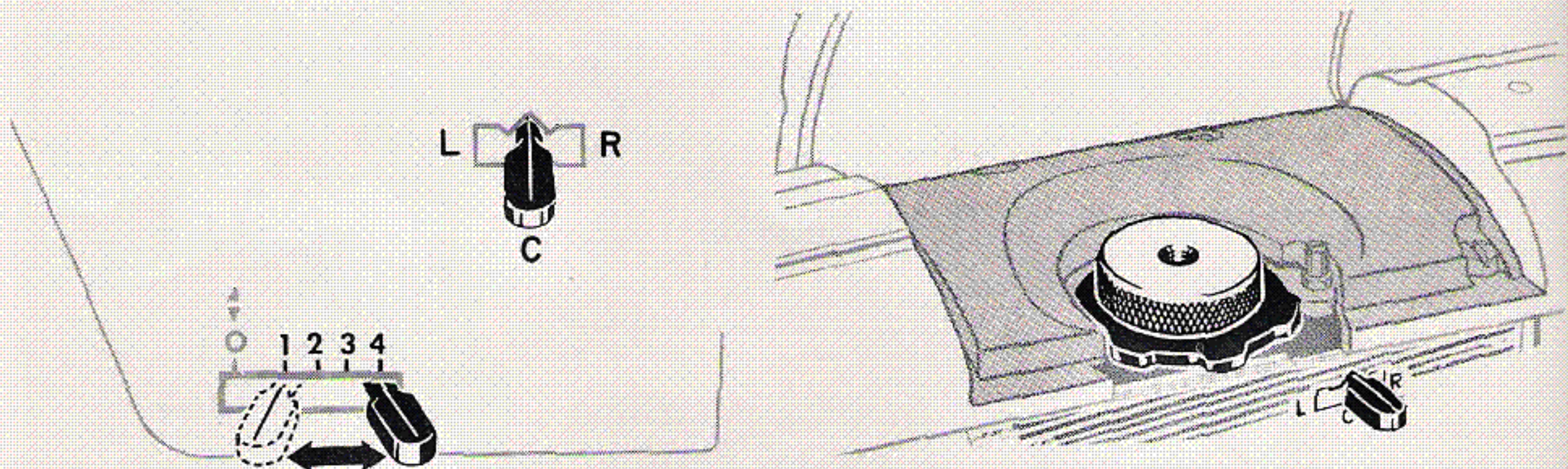

FASHION DISCS CONTROL STITCH PATTERNS.  
 NEEDLE POSITION LOCATES STITCHING AT  
 LEFT, CENTER OR RIGHT (See page 33).  
 STITCH WIDTH SELECTOR CONTROLS WIDTH OF PATTERN.  
 STITCH REGULATOR CONTROLS LENGTH OF STITCH.

Nine removable FASHION Discs are furnished with the machine. Zigzag Disc ① is supplied on the disc holder in the machine. Eight additional discs are in the attachment set. Each disc produces an individual design, and is interchangeable with the Zigzag Disc.

## REMOVAL AND REPLACEMENT OF FASHION DISCS

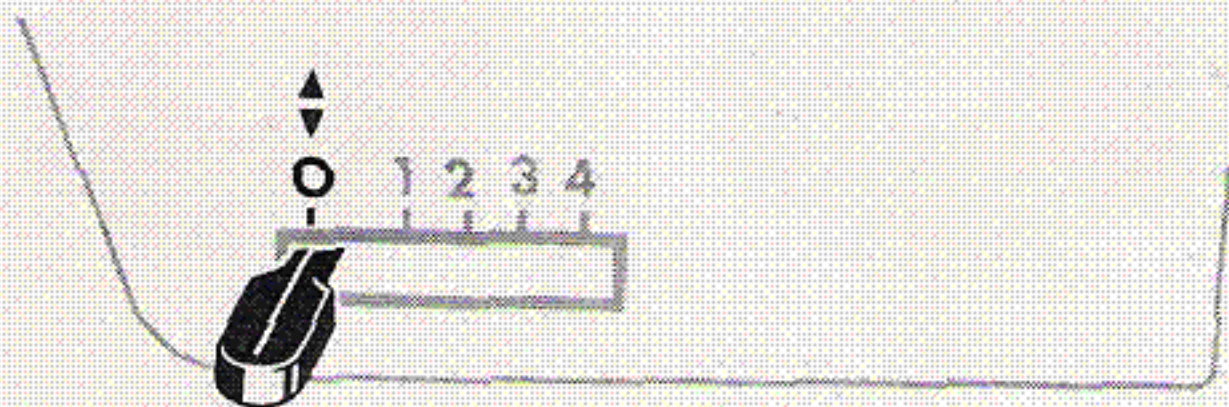

To remove and replace **FASHION Discs**, set stitch width selector at **0**. Raise disc cover on top of machine. Unscrew knurled thumb screw and lift disc from spindle. Position another disc on spindle and replace thumb screw.

Tighten screw securely.

Set needle position and stitch width selectors at desired settings.

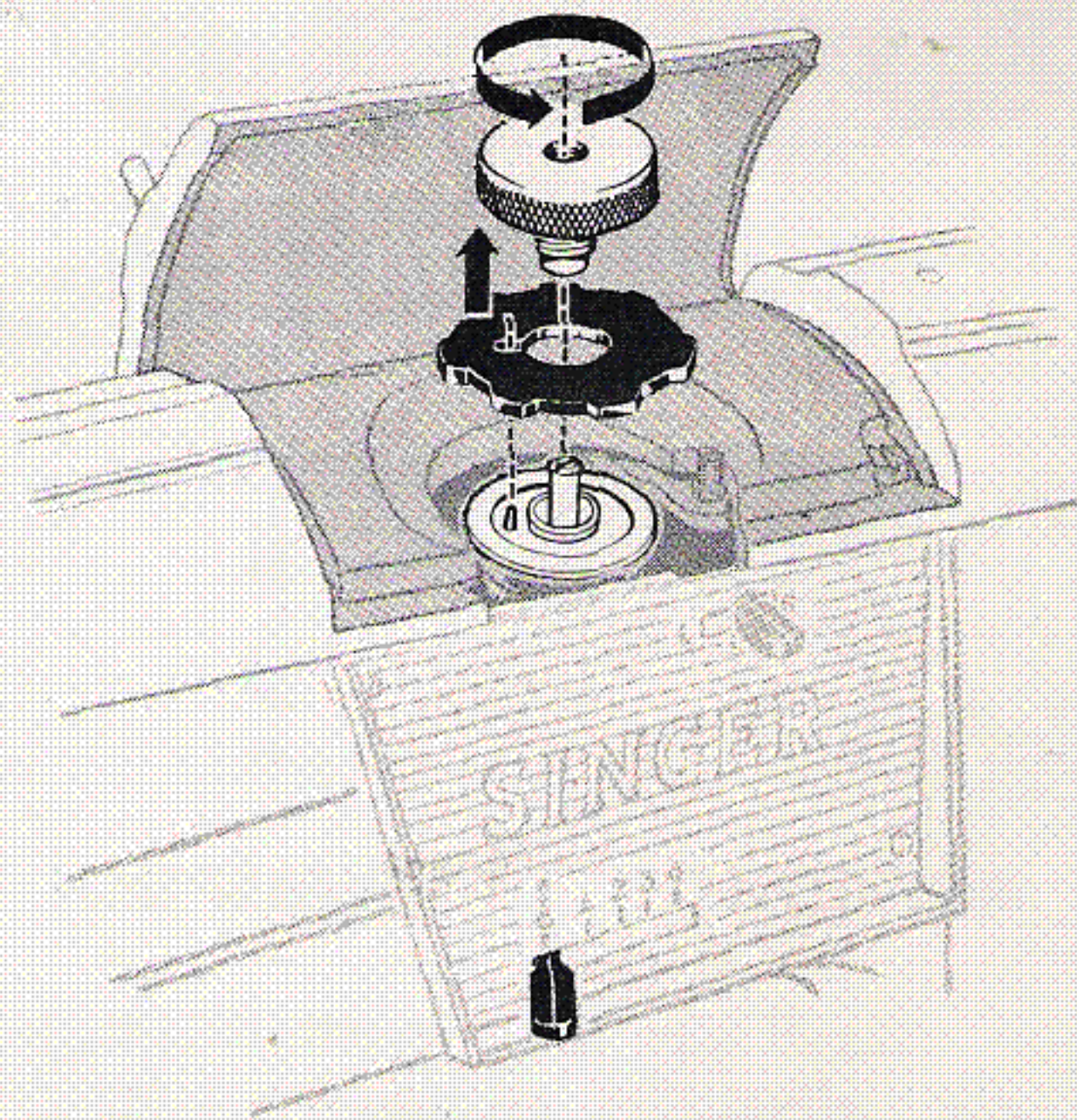

## FASHION DISCS

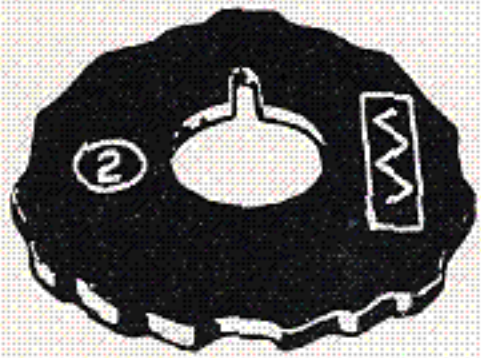

MULTI-STITCH

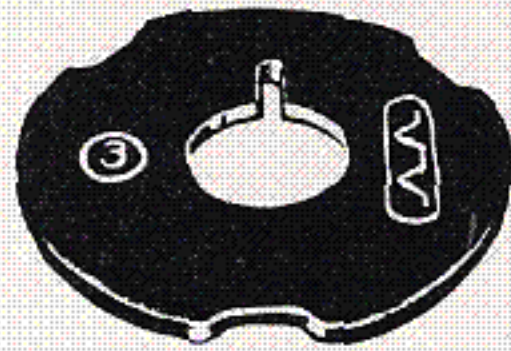

BLIND STITCH

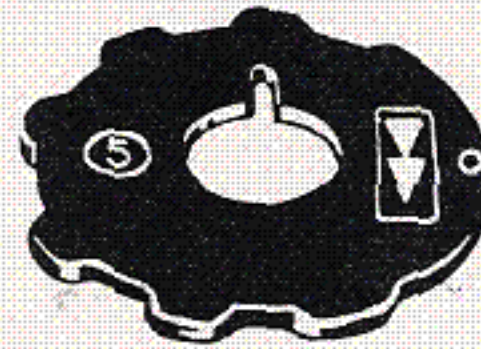

ARROWHEAD

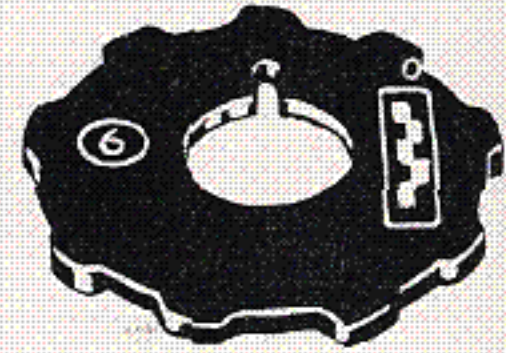

DOMINO

These four interchangeable FASHION Discs, plus the four illustrated on the next page, are included with the machine.

See page 29 for removal and replacement.

## FASHION DISCS

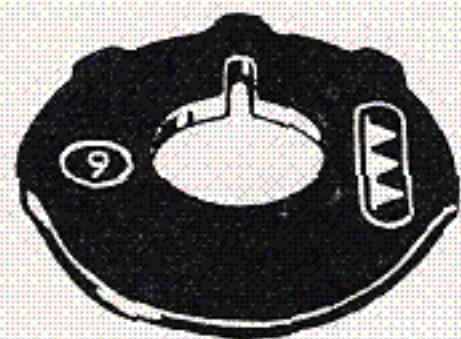

ICICLE

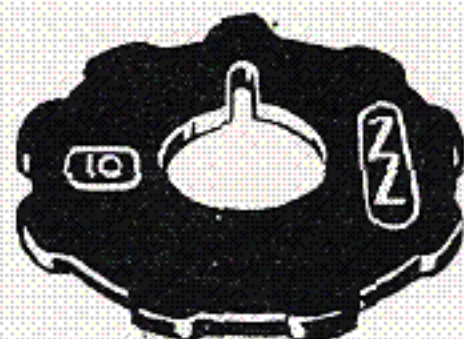

BANNER



DIAMOND

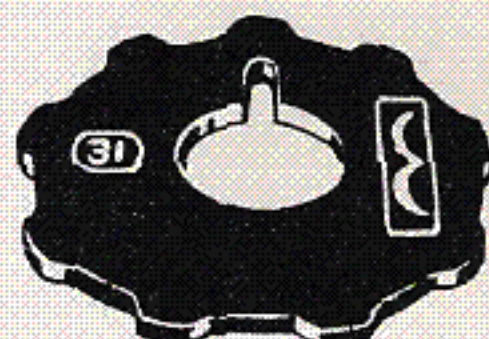

CRESCENT

These four interchangeable FASHION Discs, plus the four illustrated on the previous page, are included with the machine.

See page 29 for removal and replacement.

## CONTROL OF WIDTH — ZIGZAG STITCHING

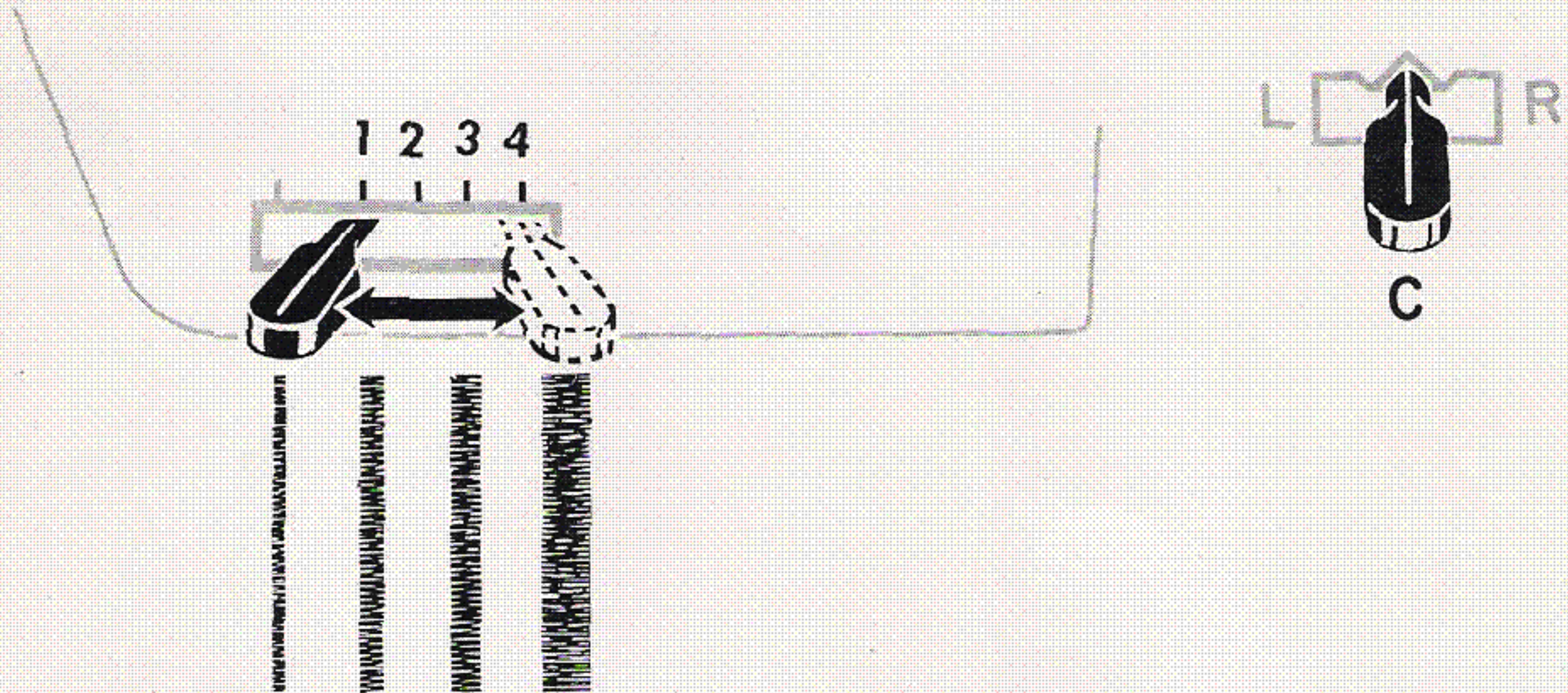

Width of zigzag stitch is controlled by the Stitch Width Selector. As the selector lever is moved to the right, the width of zigzag stitch is increased. Settings of 1 through 4 are indicated, but intermediate settings may also be used.

To avoid damage to needle and fabric, do not make any selector adjustments with the needle in the fabric.



## NEEDLE POSITIONS FOR ZIGZAG STITCHING

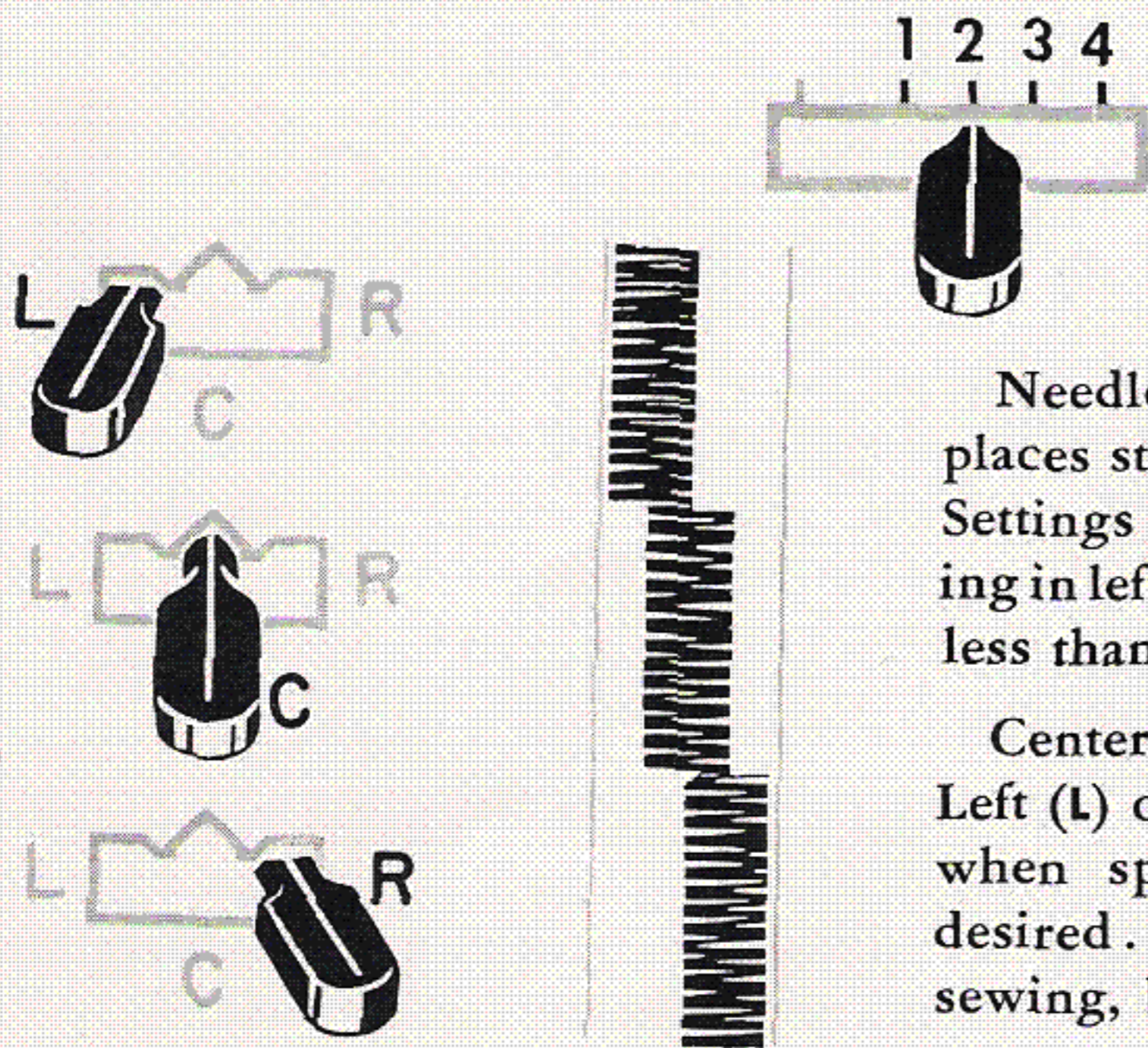

Needle position setting of **C** (Center) places stitching in central needle position. Settings **L** (Left) and **R** (Right) place stitching in left or right needle positions at widths less than 4.

Center (**C**) needle position is preferred. Left (**L**) or Right (**R**) settings are used only when special placement of stitching is desired... for example: buttonholes, button sewing, blind stitching.

Do not make any needle position adjustments with the needle in the fabric.

## STITCH LENGTH ADJUSTMENT FOR SATIN STITCHING

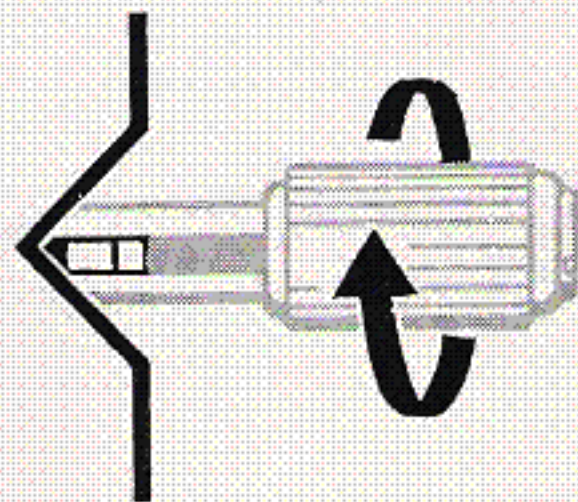
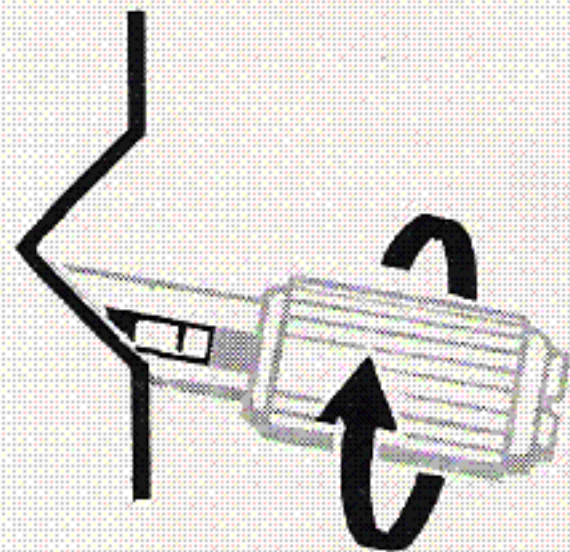
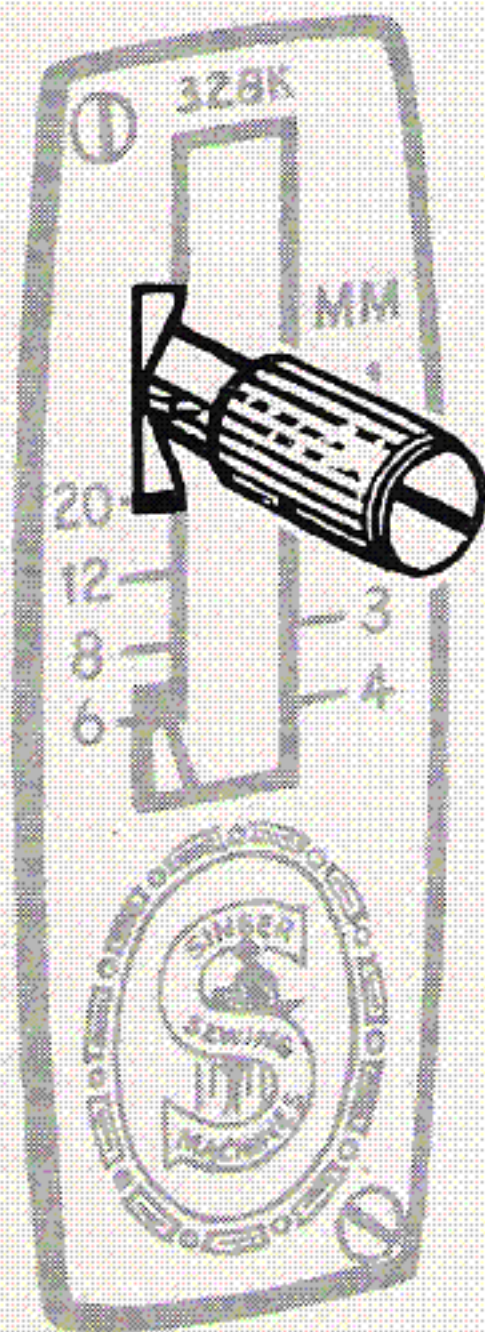

Upper inclined area of indicator plate provides a means of gradually shortening stitch length.

As knob is turned, pointer rides up incline until a closed satin stitch is obtained.

The length setting will vary with texture of fabric. Make a test on a scrap of self-fabric, using Special Purpose Foot, before proceeding with the actual work.

## TENSION ADJUSTMENT FOR SATIN STITCHING

Satin stitching requires lighter tension than straight stitching or open designs. The wider the satin stitching the lighter the tension required.

Wide satin stitching, Stitch Width Selector at 4, requires least amount of tension. For narrower satin stitching slightly more tension should be used.

To determine correct tension setting, a test sample should be made on self-fabric using Special Purpose Foot. A properly balanced satin stitch should lie flat across the material.

Some soft fabrics may require addition of a backing to insure good stitching results. Crisp organdy and lawn are suitable for this purpose.

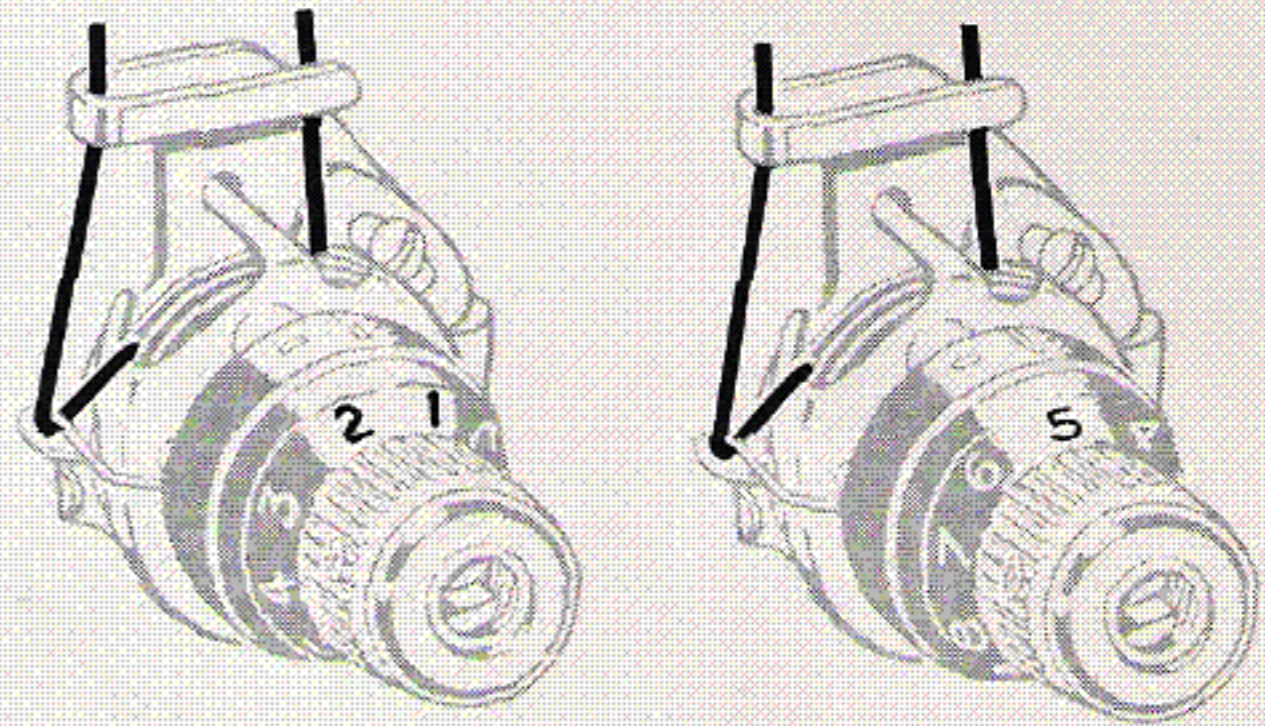

Correct

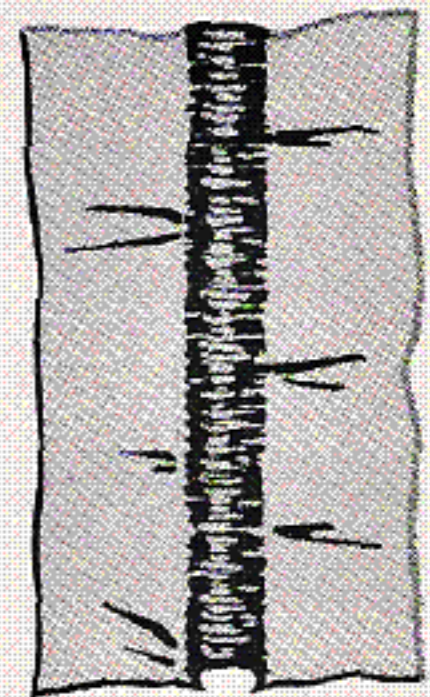

Incorrect

## TWO NEEDLES

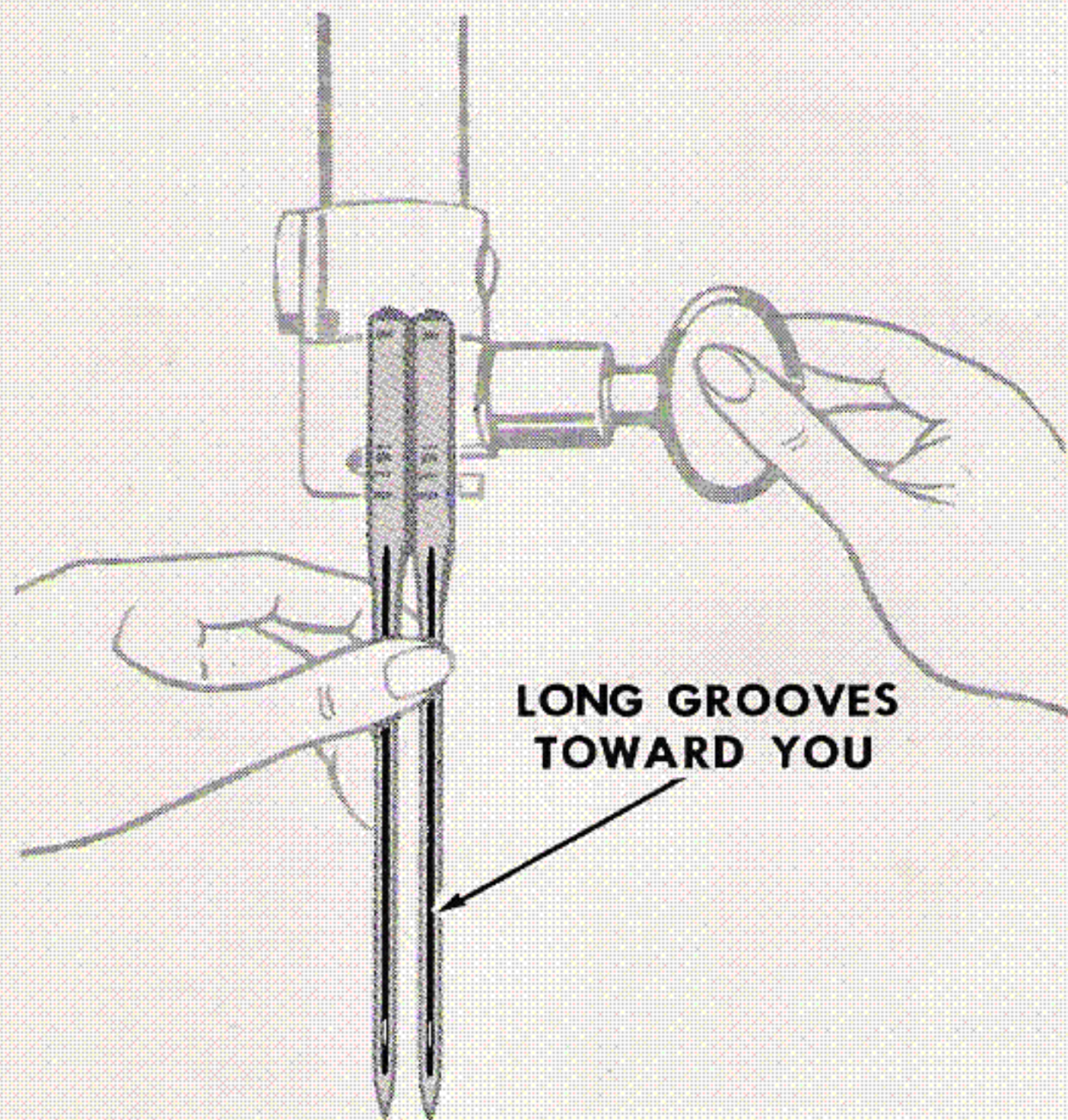

The needle clamp accommodates two needles, Catalog 2020 (15 x 1), generally of the same size. However, where special effects are desired, needles of different sizes may be used together, with corresponding threads. Loosen the thumb screw and insert the additional needle from the right.

## TWO NEEDLES — UPPER THREADING

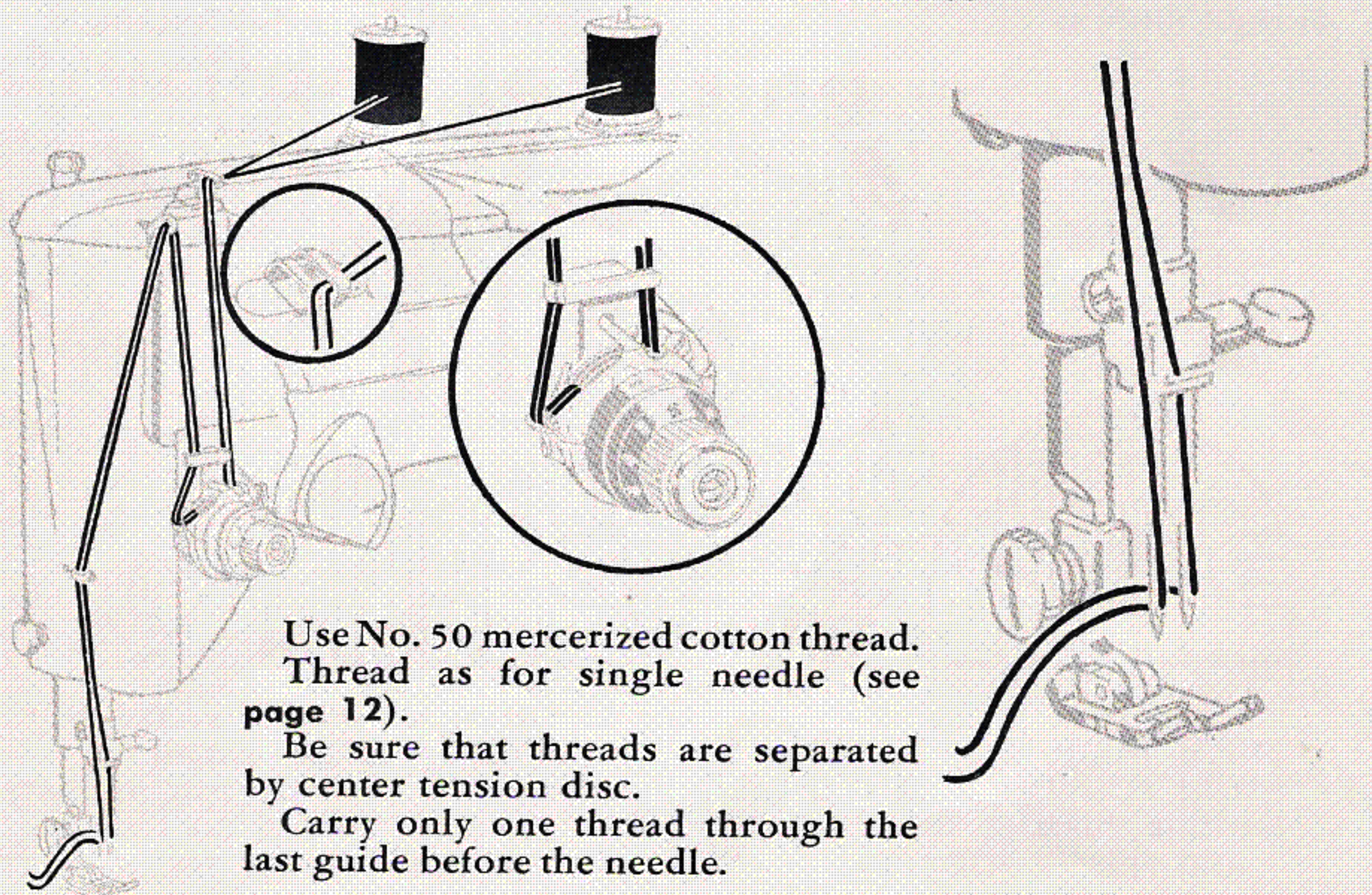

Use No. 50 mercerized cotton thread.  
Thread as for single needle (see page 12).

Be sure that threads are separated by center tension disc.

Carry only one thread through the last guide before the needle.

## TWO NEEDLES

## Straight Stitching

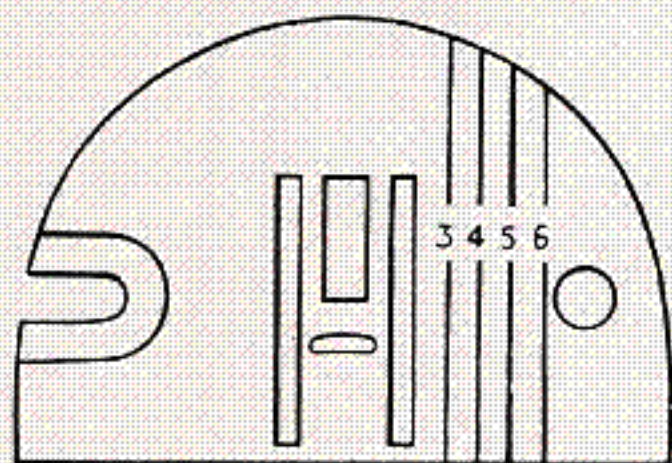
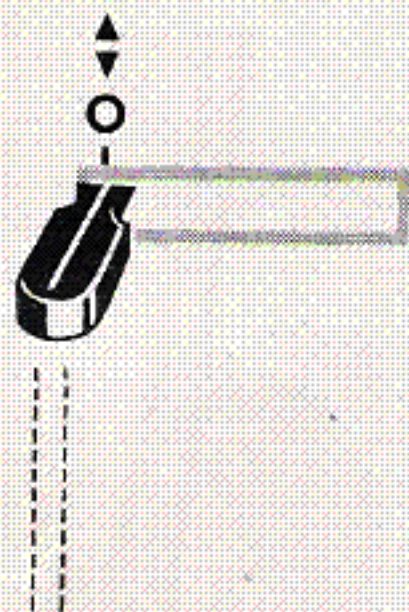

STITCH WIDTH: ○  
 NEEDLE POSITION: L OR C ONLY  
 GENERAL PURPOSE THROAT PLATE  
 AND PRESSER FOOT

## Zigzag and Decorative Stitching

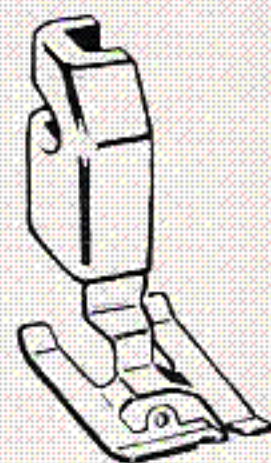
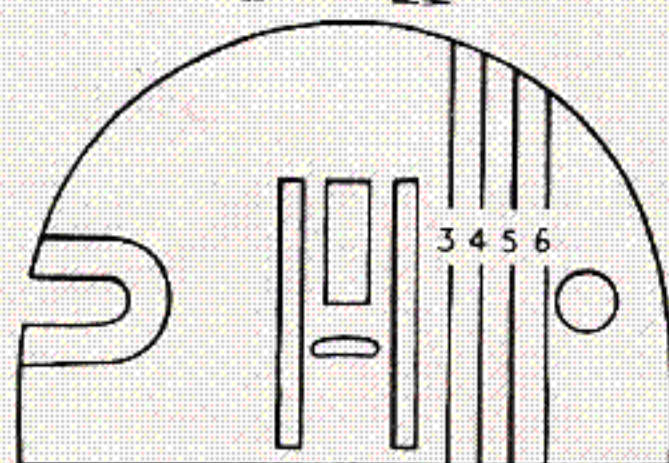
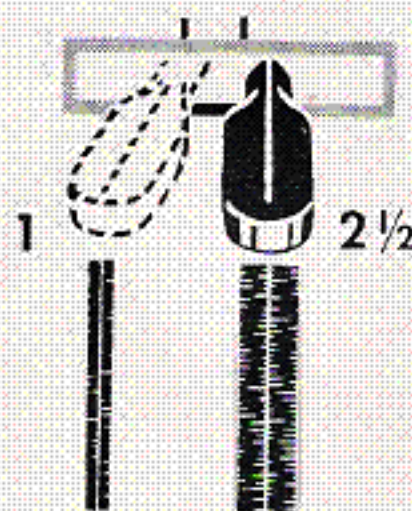

STITCH WIDTH: 2½ MAXIMUM  
 NEEDLE POSITION: L ONLY  
 GENERAL PURPOSE THROAT PLATE  
 GENERAL PURPOSE OR  
 SPECIAL PURPOSE PRESSER FOOT

# Instructions for using ATTACHMENTS . . .

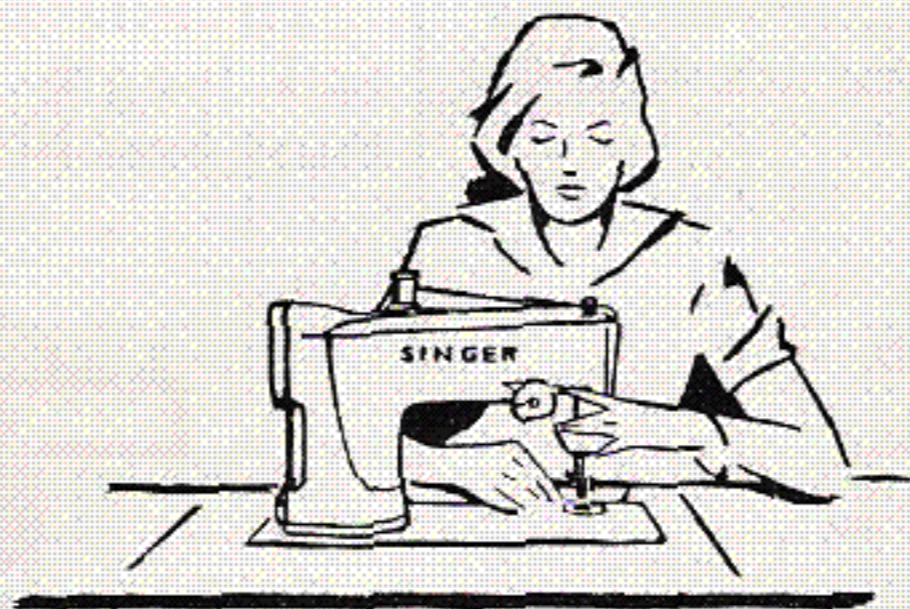

Those attachments which are not furnished with your machine are available for purchase at your local SINGER SEWING CENTRE.

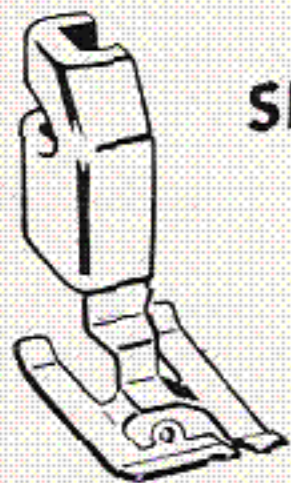

## SPECIAL PURPOSE FOOT

This light, flexible foot is designed for satin stitching. It provides maximum visibility and allows

closely spaced zigzag stitches to feed freely.

Eyelet on left side of foot accommodates a filler cord.

## APPLICATIONS

Buttonholes  
Applique  
Monograms

Decorative Stitching  
Couching  
Motifs

## BUTTONHOLES

FASHION DISC: ZIGZAG ①

STITCH WIDTH: SEE BELOW

NEEDLE POSITION: L

THROAT PLATE: GENERAL PURPOSE

SPECIAL PURPOSE FOOT

STITCH LENGTH: ABOVE 20

To establish correct stitch setting and length of buttonhole, a sample must first be made.

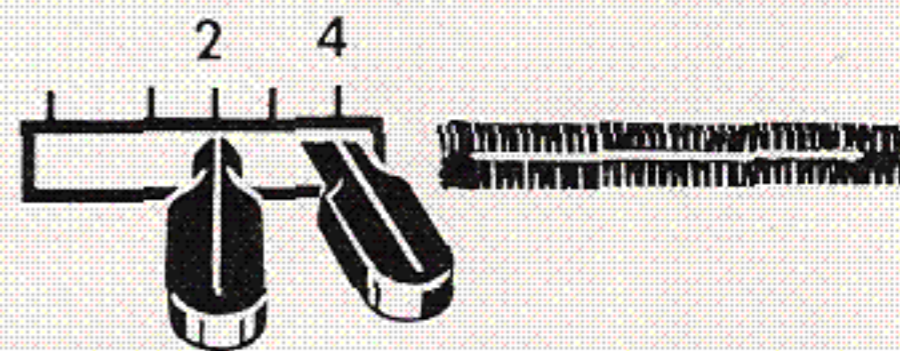



 **BUTTONHOLES (Cont'd)**

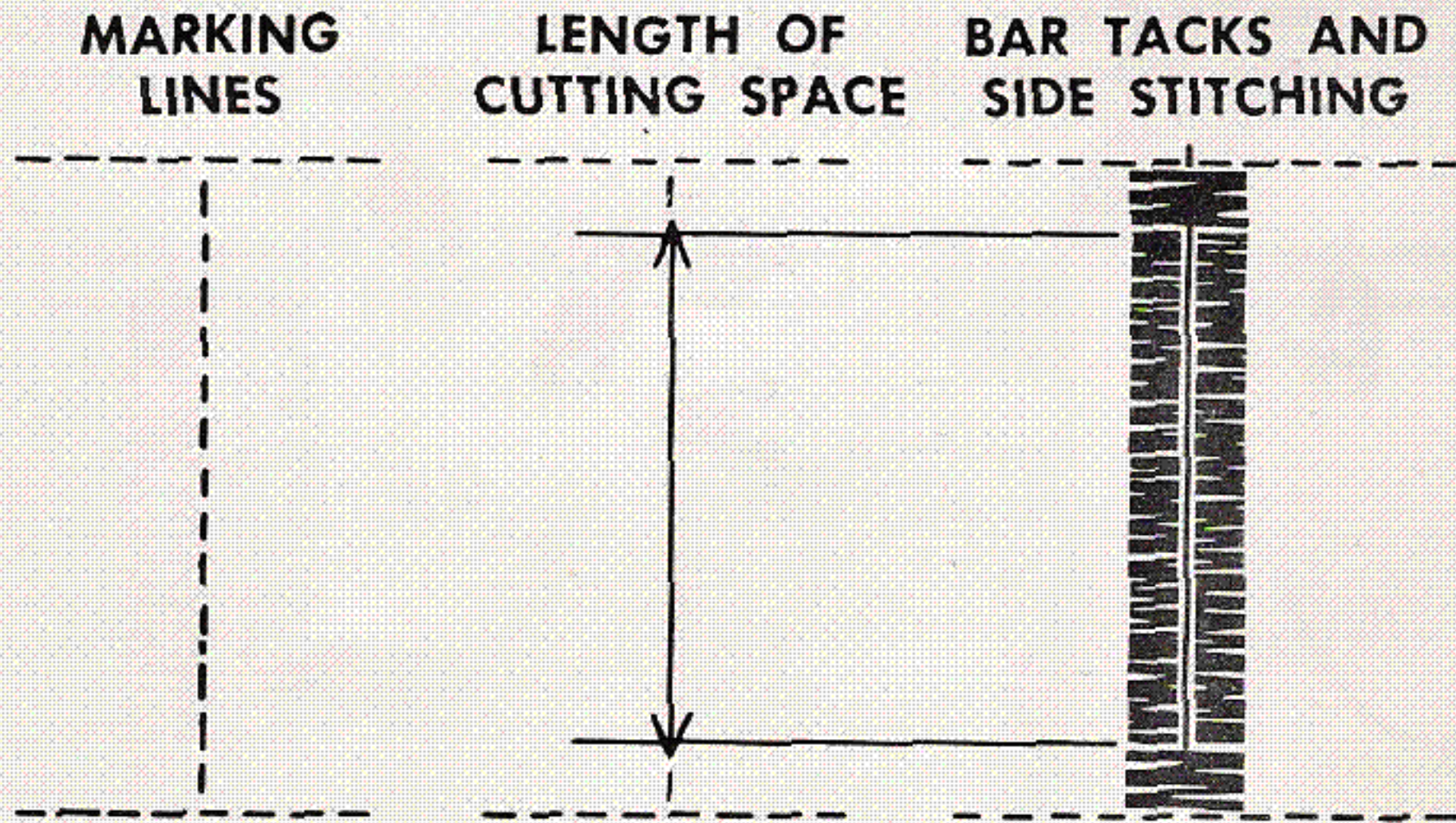

The length of cutting space, the opening through which the button passes, is measured by the width and thickness of the button.

The length of the finished buttonhole will be the cutting space plus  $\frac{1}{8}$  inch for bar tacks.

Work a sample buttonhole in the same fabric as the garment. Use a double fold, duplicating a facing, and include interfacing if this has been used.

## BUTTONHOLES (Cont'd)

**Procedure:** Set needle position at L and stitch width at 2 for side stitching (see page 40). Place work under needle, aligning center marking of buttonhole with center score line of Special Purpose Foot.

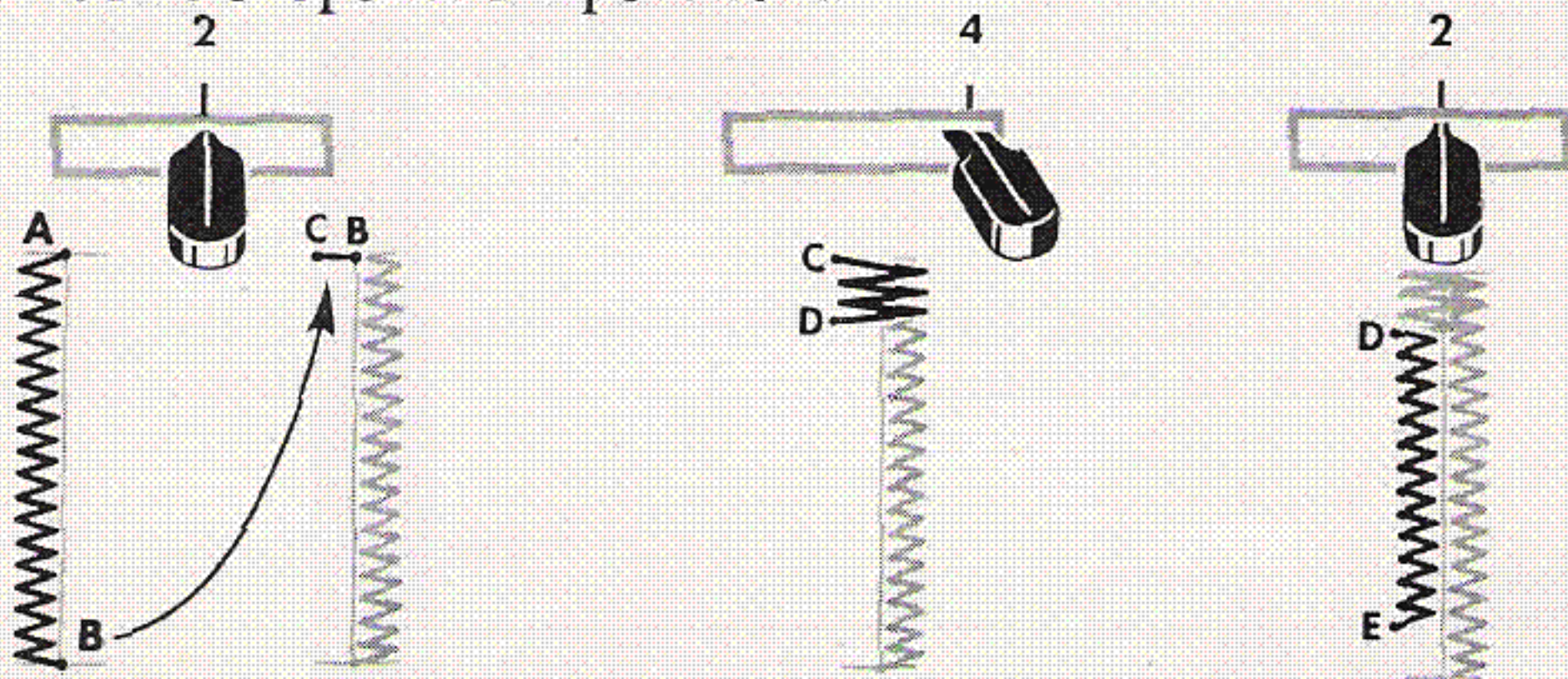

**Side Stitching:** Position needle in fabric at point A. Lower foot and stitch to end of marking. Leave needle in fabric at B. Raise foot and pivot work on needle. Lower foot, and take one stitch without changing lever setting, bringing work to C.

**Bar Tack:** With needle in fabric, raise presser foot and set stitch width at 4. Lower foot and take approximately six stitches to complete tack. Leave needle in fabric at point D.

**Side Stitching:** With needle in fabric, raise presser foot and re-set stitch width at 2. Lower presser foot and stitch to point E. Leave needle in fabric at point E.

## BUTTONHOLES (Cont'd)

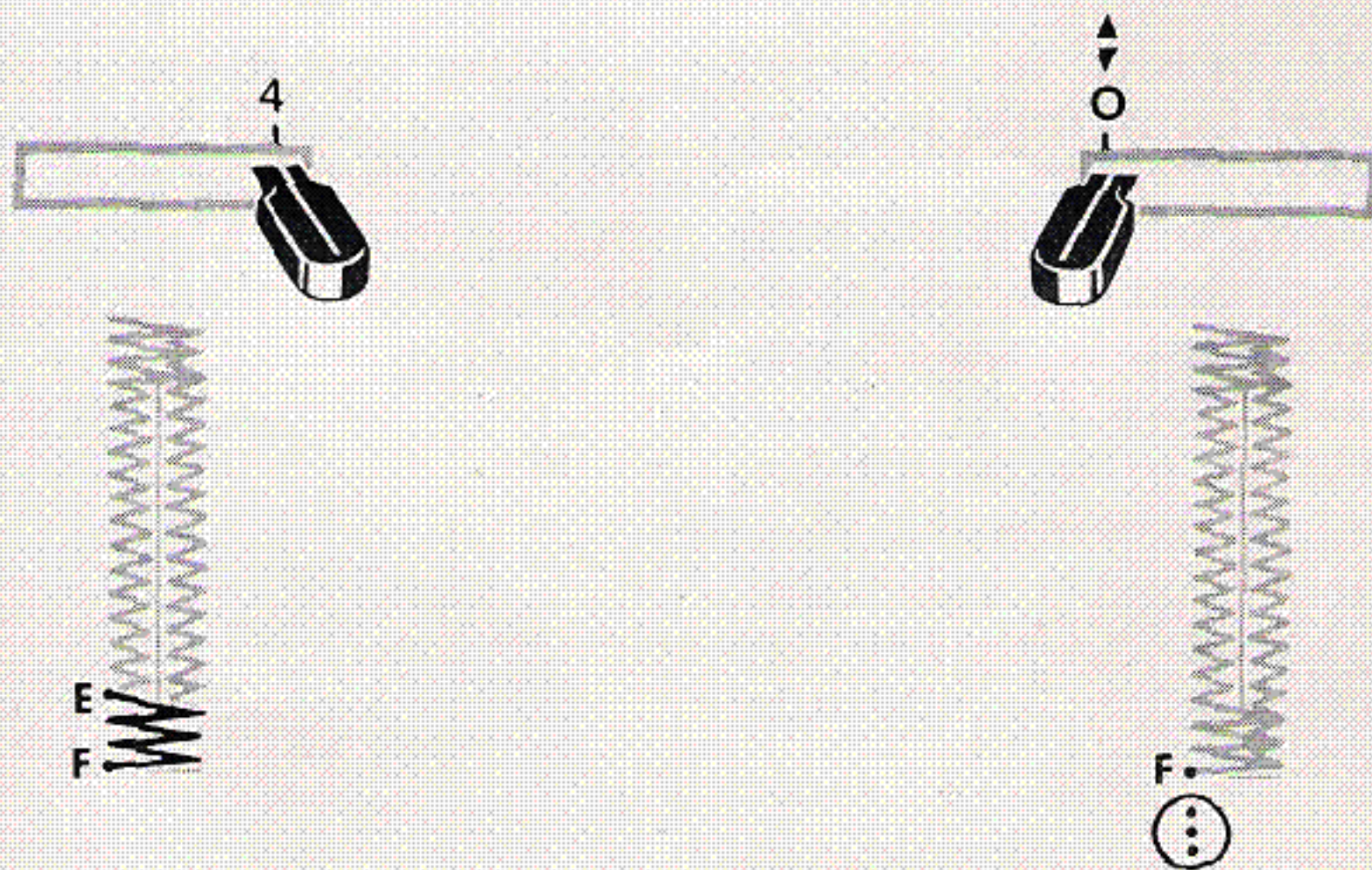

**Final Bar Tack:** With needle in fabric, raise presser foot and set stitch width at 4. Lower presser foot and duplicate tack previously made. **Leave needle in fabric at point F.**

**Fastening Stitch:** With needle in fabric, raise presser foot and set stitch width at 0; lower foot, take approximately three stitches.

Remove work, draw threads to wrong side and trim. Cut opening for button with a pair of sharp embroidery scissors.

## APPLIQUE

Applique adds beauty to wearing apparel, linens and household textiles.

Either contrasting or self-fabric may be used effectively. Most versatile stitch for applique is a closely set Zigzag stitch (FASHION Disc ①). Stitch width may be varied to accommodate weaves and textures of fabrics.

Many of the FASHION Disc patterns present interesting ways to applique with decorative stitching.

**Preparation:** Position design and baste it to fabric. Attach Special Purpose Foot to presser bar.

**Procedure:** Set needle position at **C** and stitch width at **0** for straight stitching. Outline entire design with a short stitch. Trim raw edges close to stitching.

Select and insert desired FASHION Disc, set stitch width selector at desired setting, and overedge design with this stitching. A smooth uniform finish results, which requires no additional trimming.

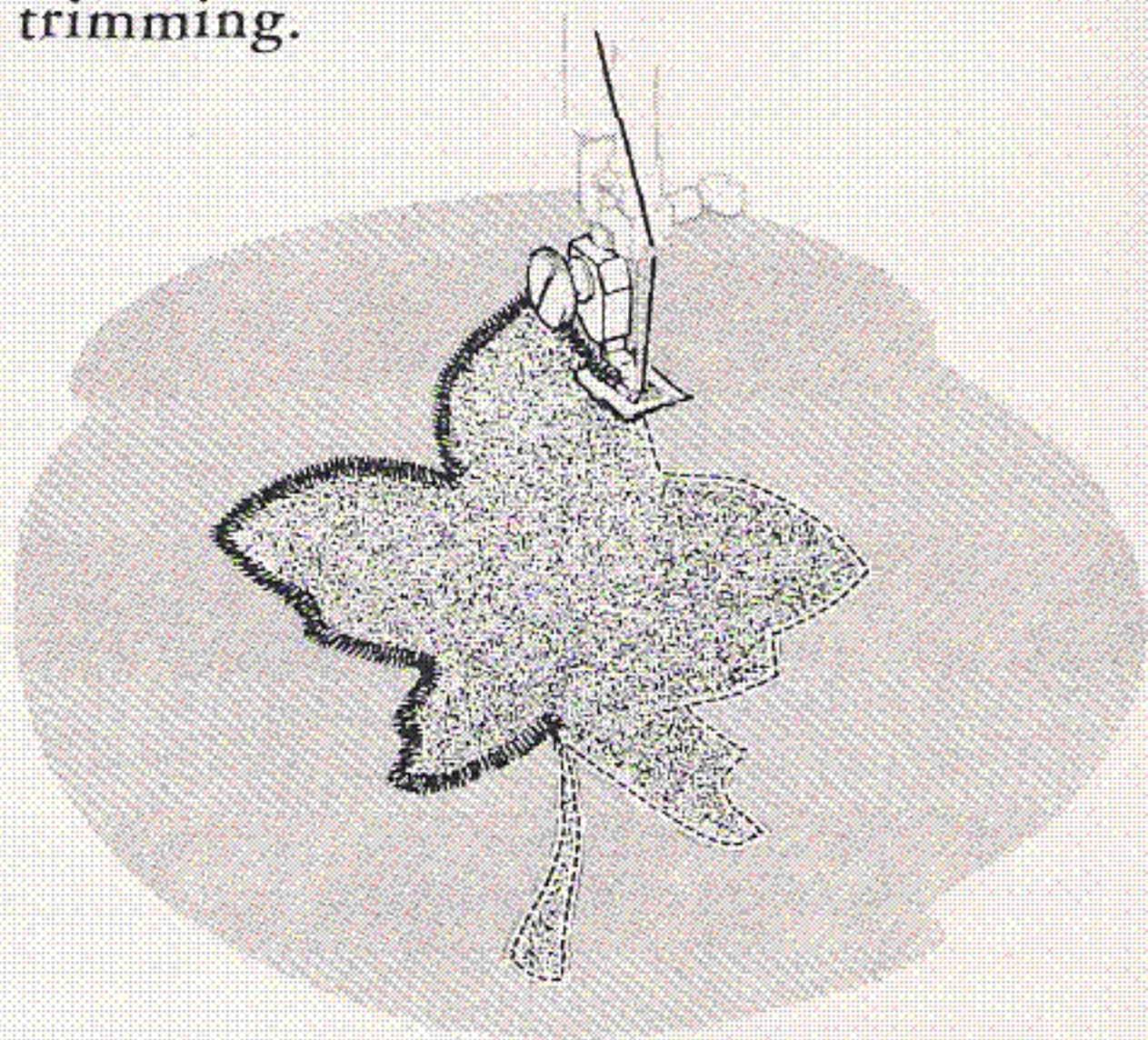

## MONOGRAMS AND MOTIFS

Many of the decorative stitch patterns lend themselves to the creation of attractive and unusual monograms and motifs.

Select a simple transfer design, or sketch one to suit your purpose. Position design, and transfer or trace to right side of material.

When working a design on a single thickness of fabric, a backing is essential. Crisp lawn or organdy is suitable for this purpose, and may be trimmed close to stitching when work is completed.

A test sample should be made before proceeding with actual work to determine stitch setting and spacing. The Special Purpose Foot is especially designed for accurate satin stitch placement.

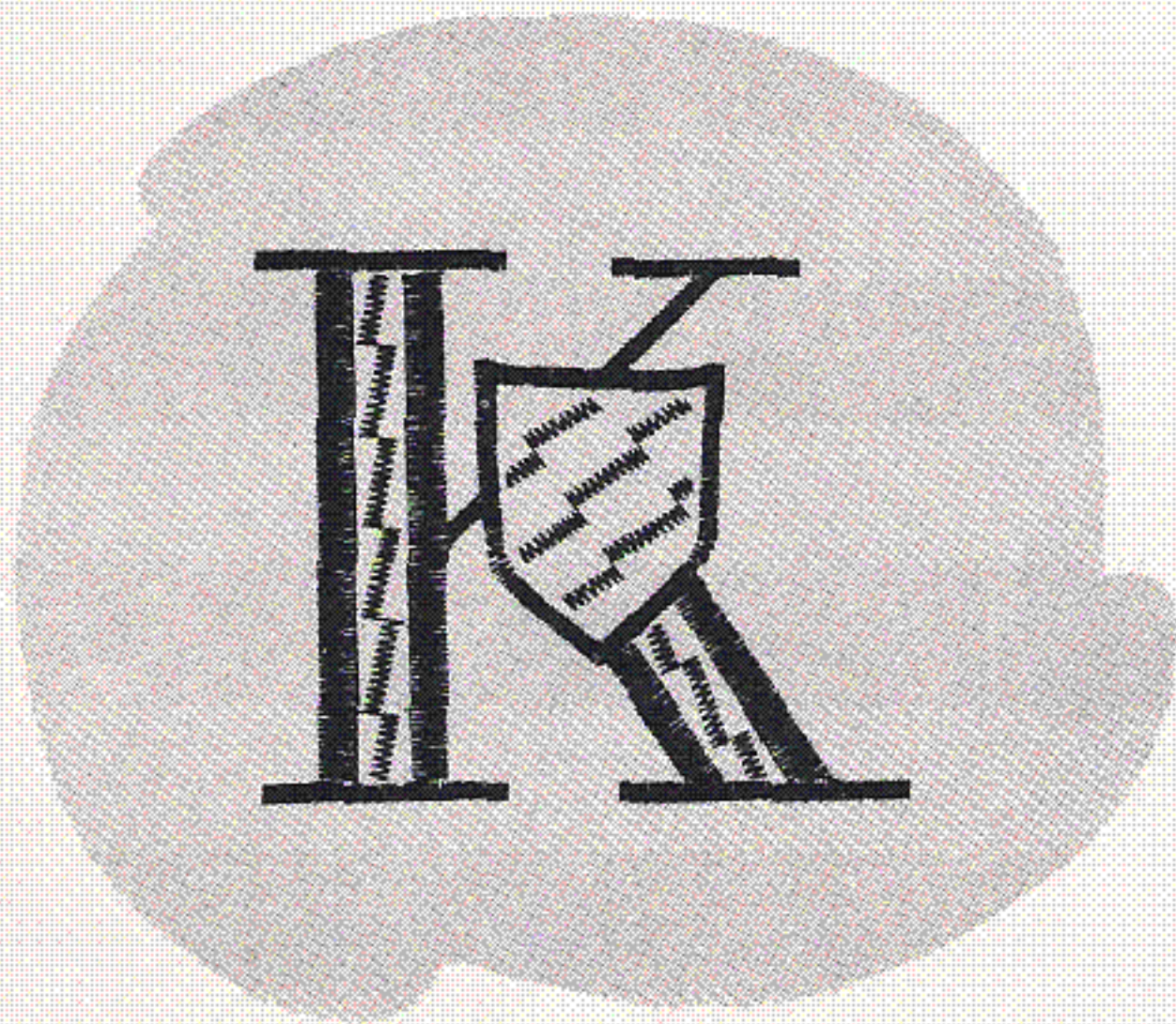



## BUTTON SEWING FOOT

This short, open foot accommodates any two hole or four hole button, and holds it securely for stitching. Groove in foot allows for insertion of a machine needle, over which a thread shank may be formed.

FASHION DISC: ZIGZAG ①  
 STITCH WIDTH: 0 AND 3  
 NEEDLE POSITION: L  
 THROAT PLATE: GENERAL PURPOSE  
 WITH LIFTING PLATE  
 BUTTON SEWING FOOT

Space between holes in button determines width of stitch settings. Settings 0 and 3 generally apply to standard buttons. The 0 setting is constant, but 3 can be increased or decreased to accommodate buttons with unusual spacing.

With FASHION Disc ① in place, set needle position selector at L and stitch width selector at 0.

Remove throat plate (see page 14). Insert lifting plate as shown below.

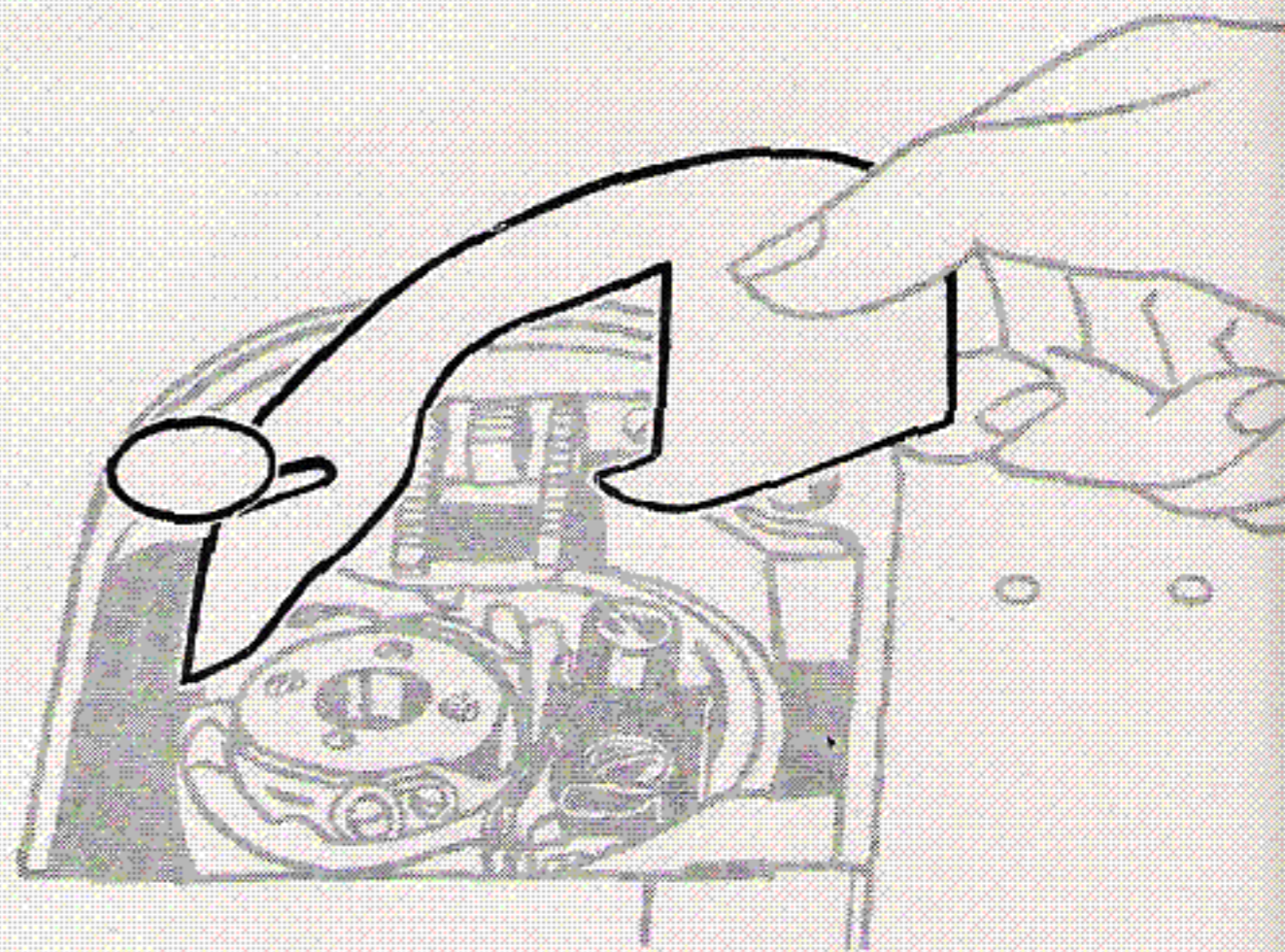

Insert general purpose throat plate over lifting plate.

## BUTTON SEWING (Cont'd)

Position button under foot so that needle will enter into left hole. Lower foot. Turn hand wheel toward you until needle rises out of fabric and is just above foot.

Set stitch width selector at 3. Needle should then enter into right hole in button. Take approximately six zigzag stitches at this setting. End on left side. To fasten stitching, adjust to 0 and take three stitches.

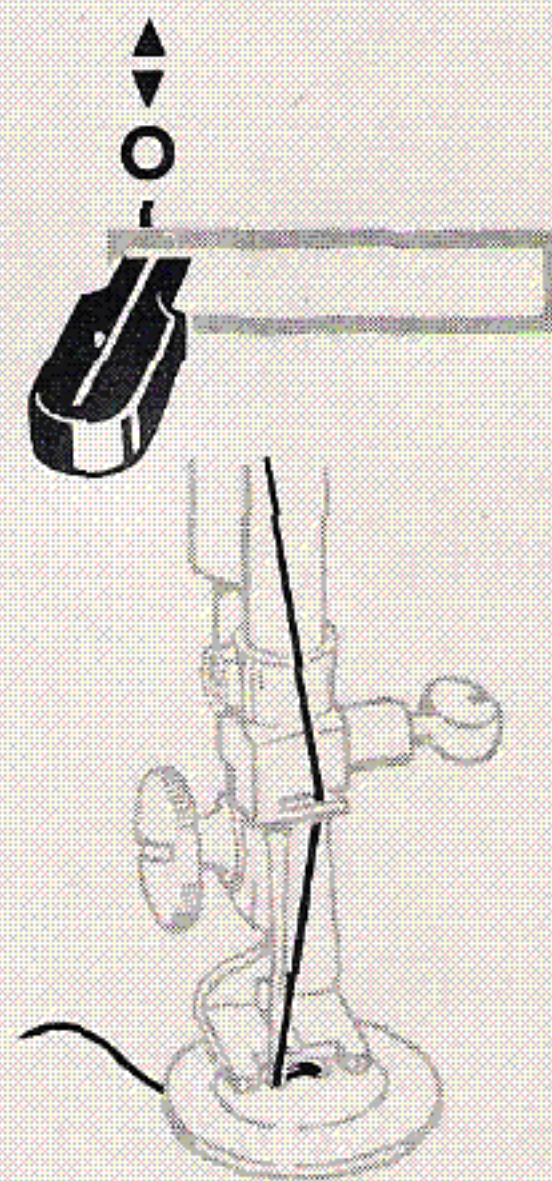
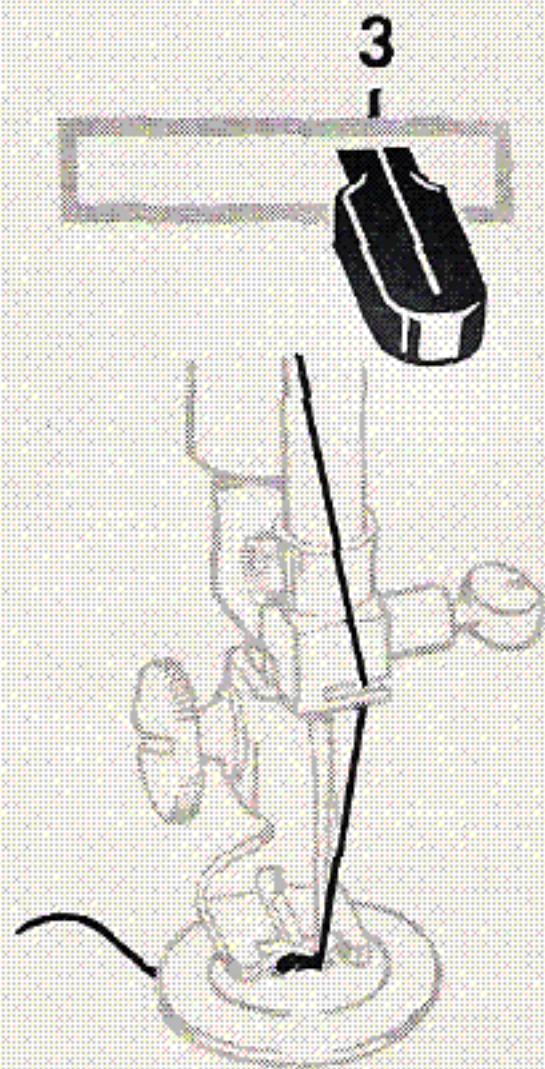
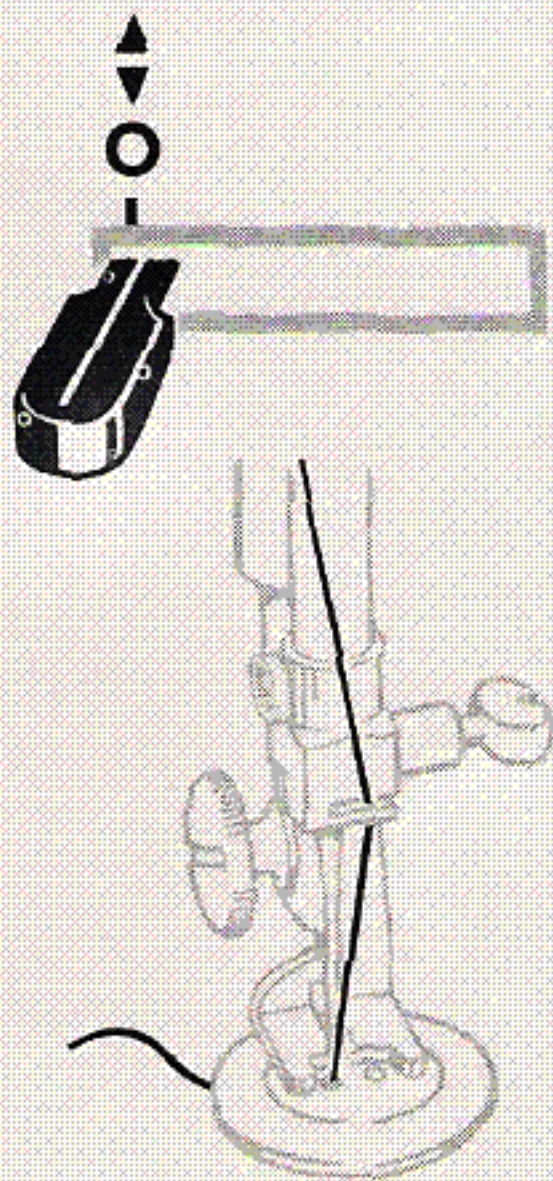



## GENERAL PURPOSE FOOT

Used with general purpose throat plate, this foot provides a wide needle slot which accommodates all stitch settings and can be used for most sewing operations.

### APPLICATIONS

Seams and Darts  
Mending

Seam Finishes  
Blind Stitched Hems

### LINGERIE SEAMS

Dainty lingerie seams are made durable and rip-proof with Zigzag stitching (FASHION Disc ①). After straight

stitching seams on wrong side, press both seam allowances in same direction. From right side, top stitch with a fine zigzag setting ( $1\frac{1}{2}$  width), letting needle alternately enter seam line and seam thicknesses. This finish is particularly suitable for bias seams.

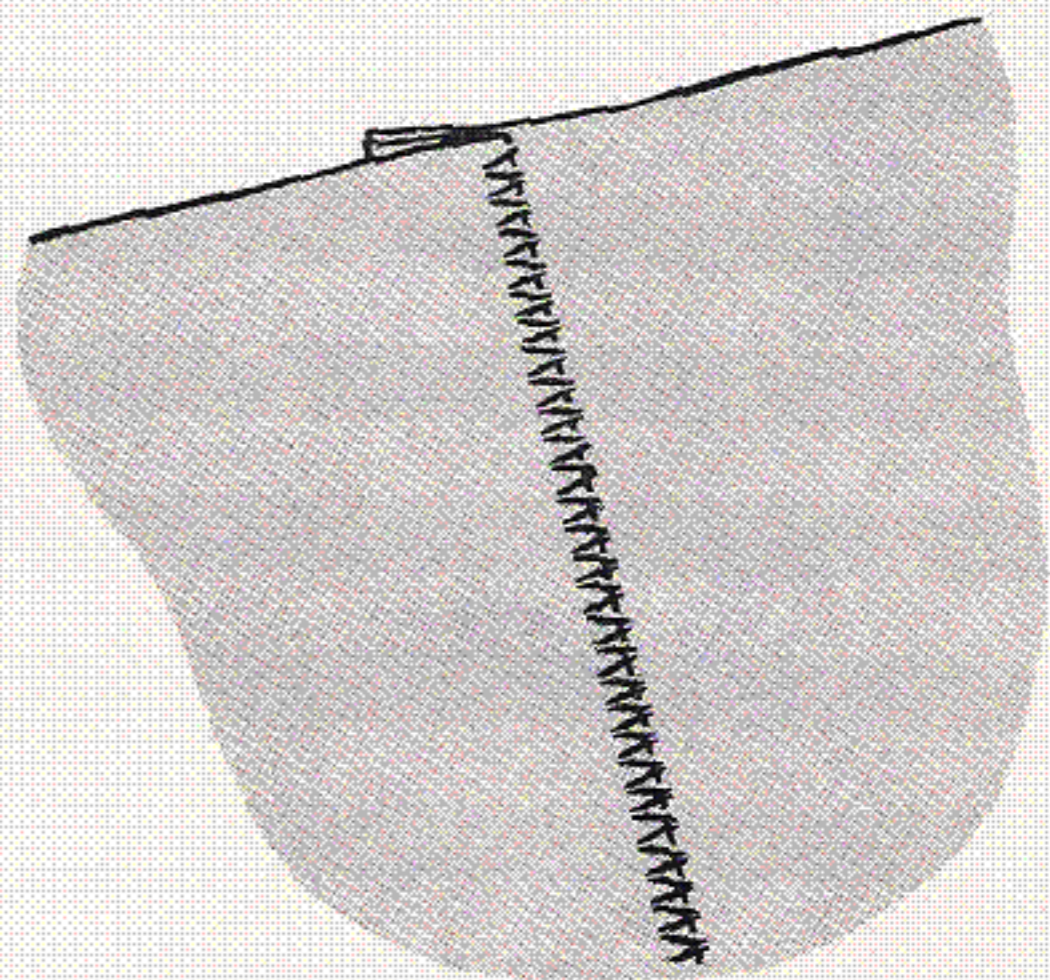



## SEAMS (Cont'd)

*Knit Fabric Seams.* A narrow Zigzag stitch (FASHION Disc ①) is ideal for seaming knit fabrics. It is particularly suitable for underarm seams, or other seams where elasticity and give are needed.

For curved or bias seams, where a stay is needed to prevent undue stretching, this same stitch can be used to apply seam tape. To insure a flat, smooth finish, position tape with edge exactly on seam line. If seam is curved, pre-shape tape to fit by steaming, and baste in place.

Proceed to stitch, allowing needle to alternately enter seam tape and seam line.

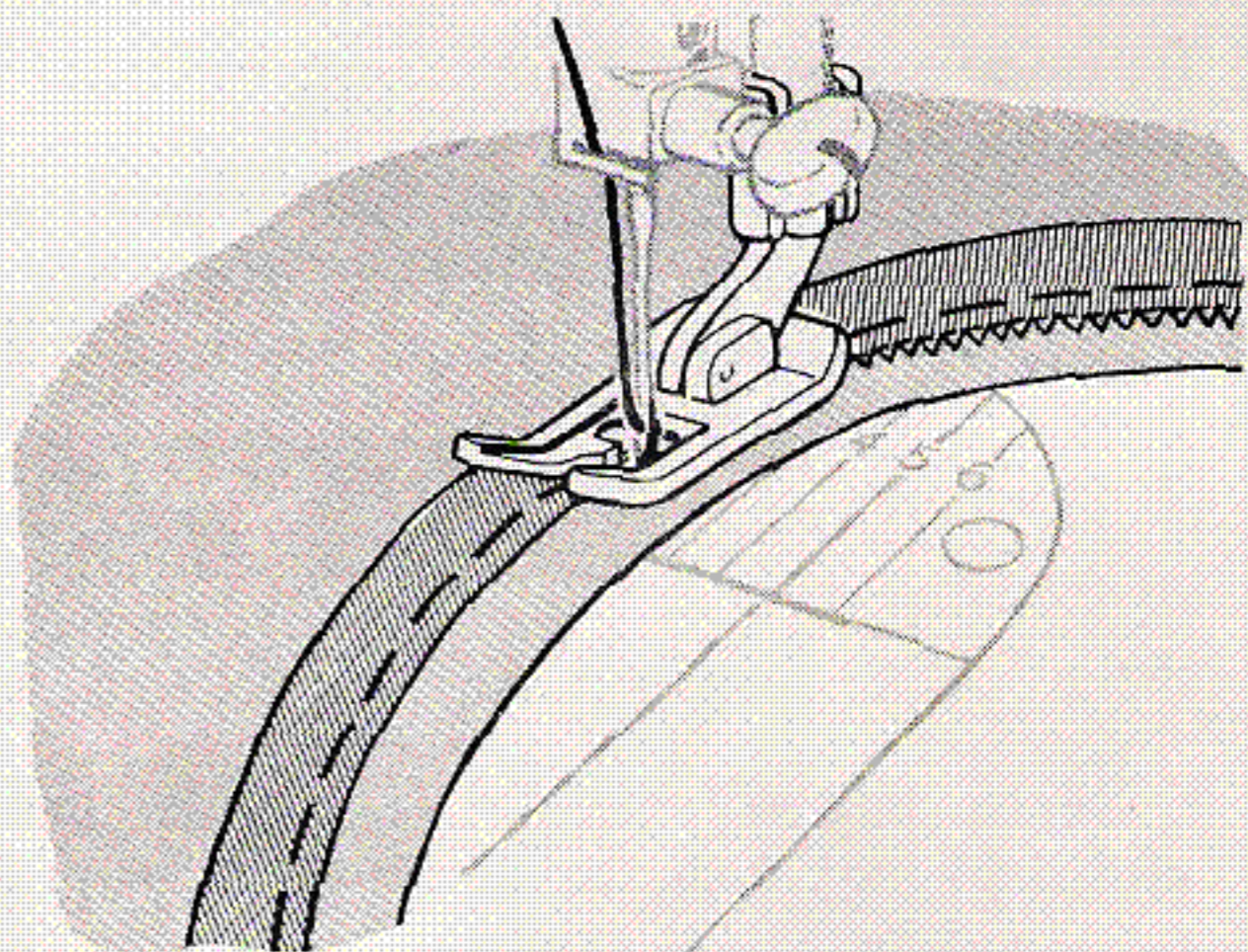

## DARTS IN INTERFACING

Non-woven interfacings can be shaped without bulk with Zigzag stitching (FASHION Disc ①). Multiple Stitch Zigzag FASHION Disc ② may also be used.

Cut out dart allowance on stitching line and bring raw edges together. Pin over a muslin stay and stitch. Back stitch at both ends.

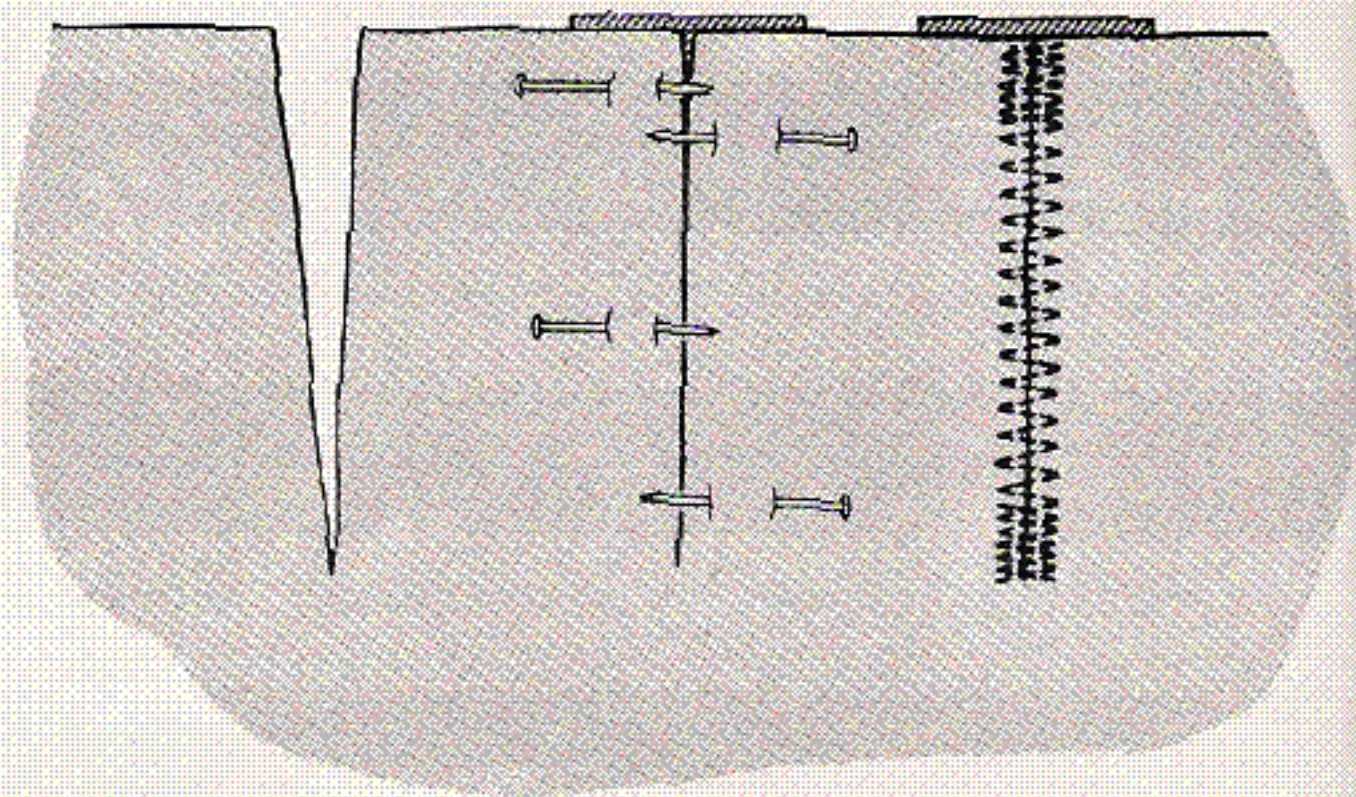

## SEAM FINISHES

Seam edges support garment and should be given a durable finish where fabrics have a tendency to ravel.

Zigzag stitch (FASHION Disc ①) is ideal for such finishing. Place stitching near edge of seam allowance, and then trim excess fabric.

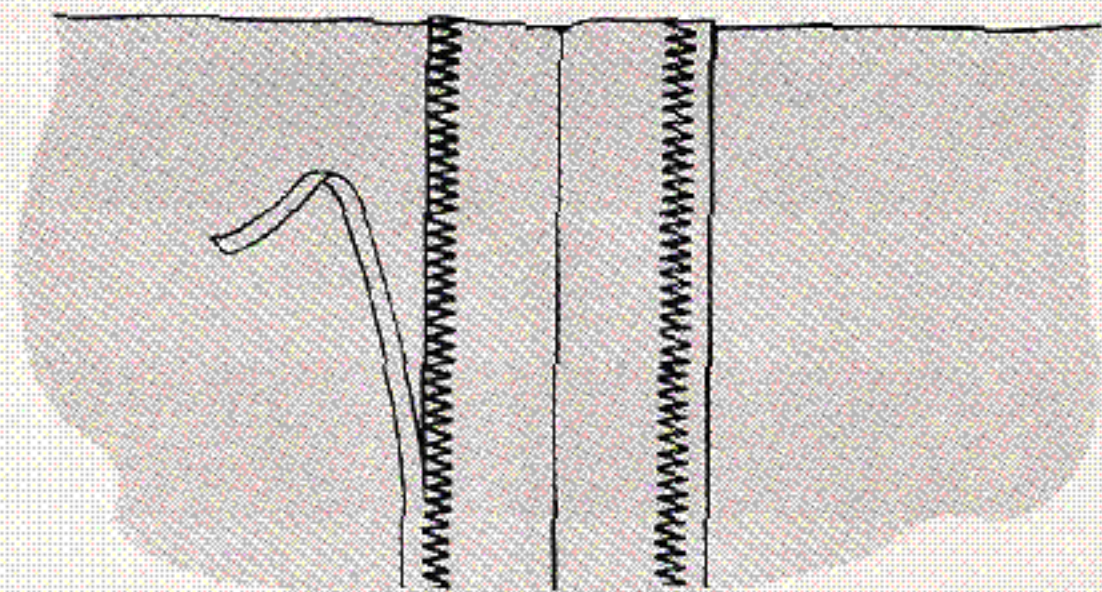

## MENDING

Zigzag stitching is well suited for all types of household mending. Multiple Stitch Zigzag (FASHION Disc ②) provides a firm, flexible bond for repair of tears, and is ideal for reinforcement and application of elastic. Stitch length and width are regulated according to need.

**Tears.** Trim ragged edges and reinforce tear with underlay. Shorten stitch length at ends and corners for added strength.

**Application of Elastic.** Elastic must be stretched as it is applied to insure fullness required in the garment.

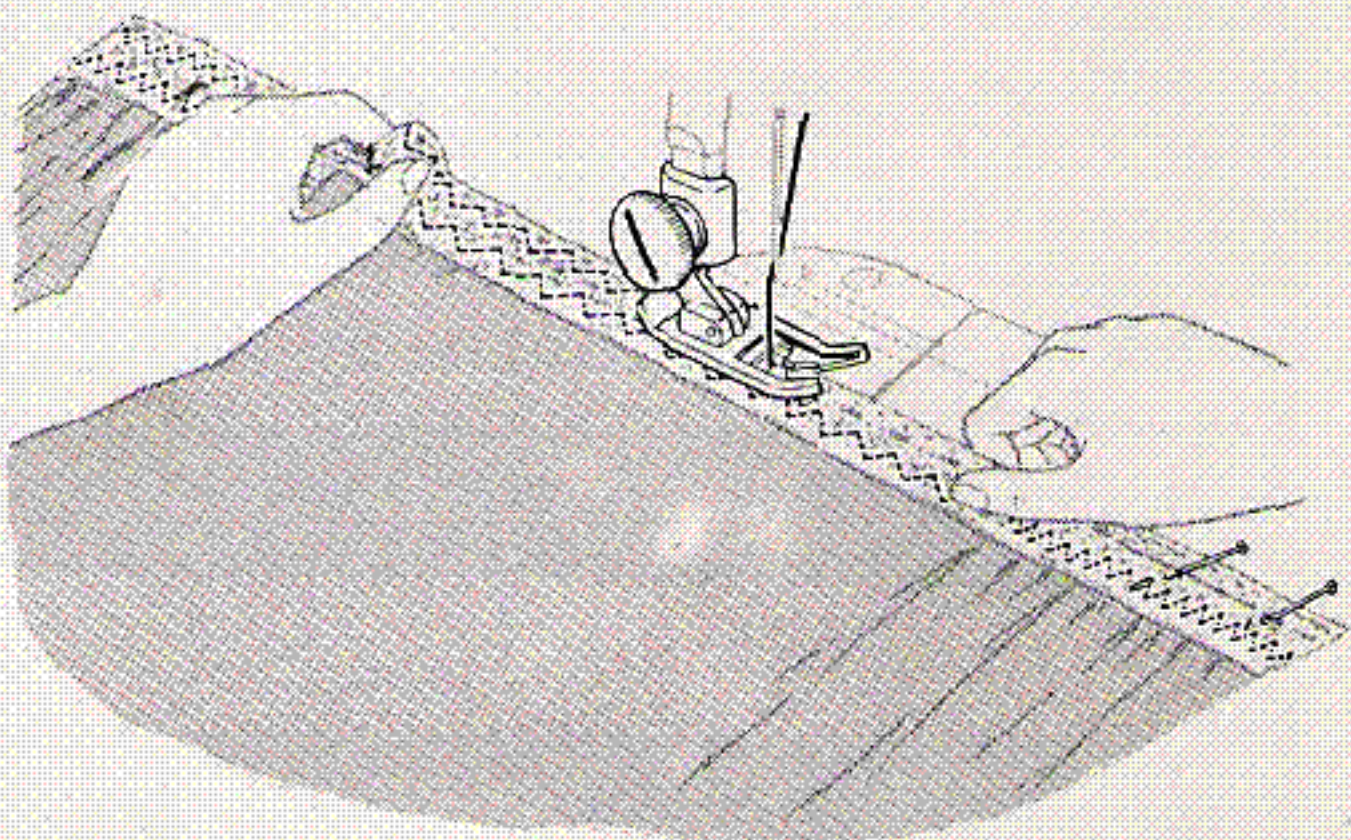
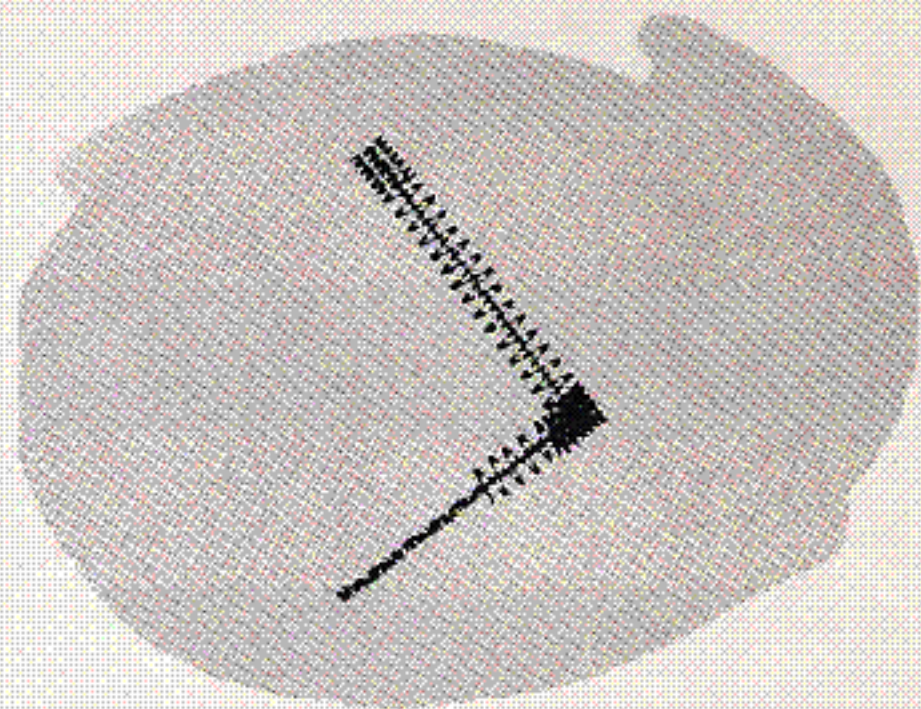

## THE SEAM GUIDE

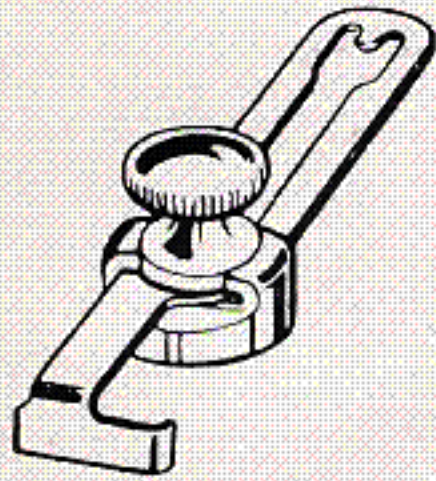

The seam guide aids in attaining uniformity of seam width. It provides for stitching to be placed at any distance between  $\frac{1}{8}$ " to  $1\frac{1}{4}$ " from edge of fabric.

### APPLICATION

Seams	Blind Stitching
Top Stitching	Decorative Stitching

Attachment is used in connection with a presser foot. It is secured to bed of machine in either of threaded holes to right of needle.

## SEAMS

*For straight seams.* Align guide with presser foot. Adjust machine for straight stitching. Pin seam edges and baste if necessary. Guide fabric edges lightly against guide while stitching.

*For curved seams:* Set attachment at an angle so that end closest to needle acts as a guide. Shorten stitch length for greater elasticity and strength.

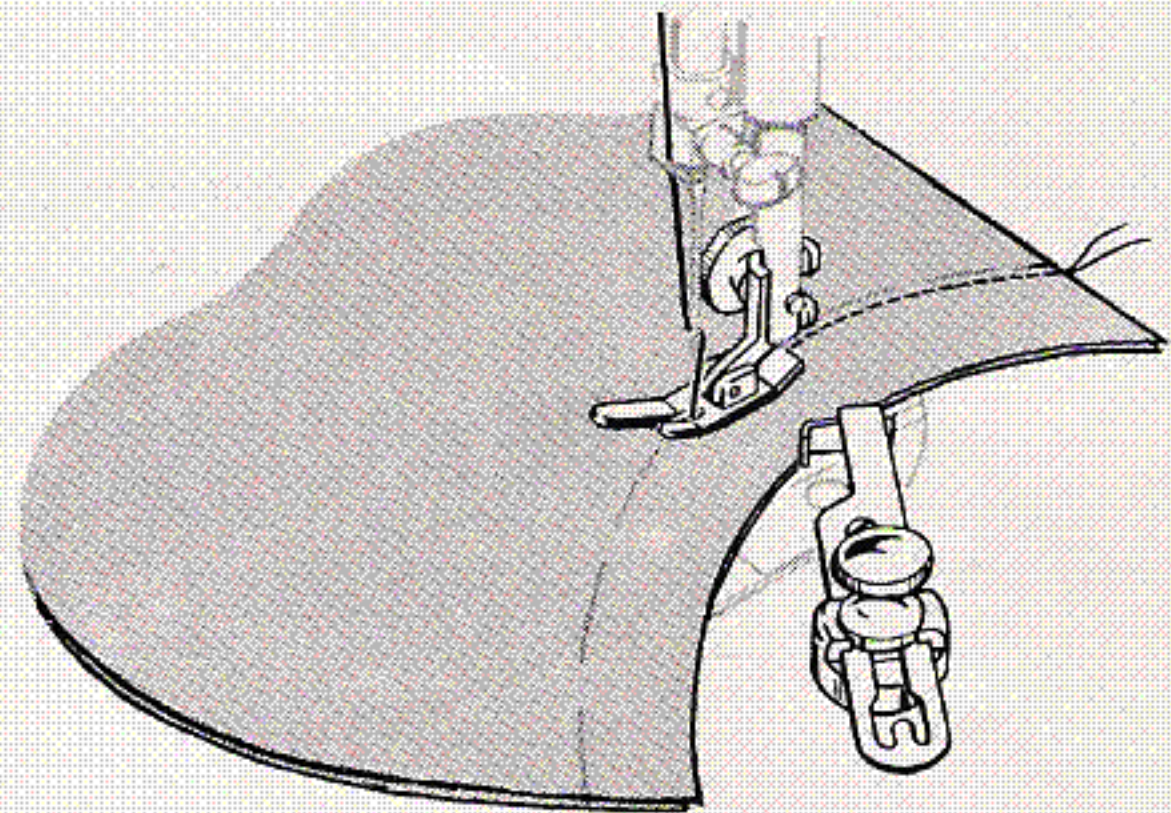

## BLIND STITCHED HEMS

FASHION DISC: BLIND STITCH ③  
 STITCH WIDTH: 2-4  
 NEEDLE POSITION: C  
 STITCH LENGTH: 10-15  
 GENERAL PURPOSE THROAT PLATE  
 AND PRESSER FOOT  
 SEAM GUIDE

Blind stitching provides a durable hem finish almost invisible and comparable to hand sewing.

Mark, turn and press hem in usual way. Baste a guide line  $\frac{1}{4}$ " from top hem edge.

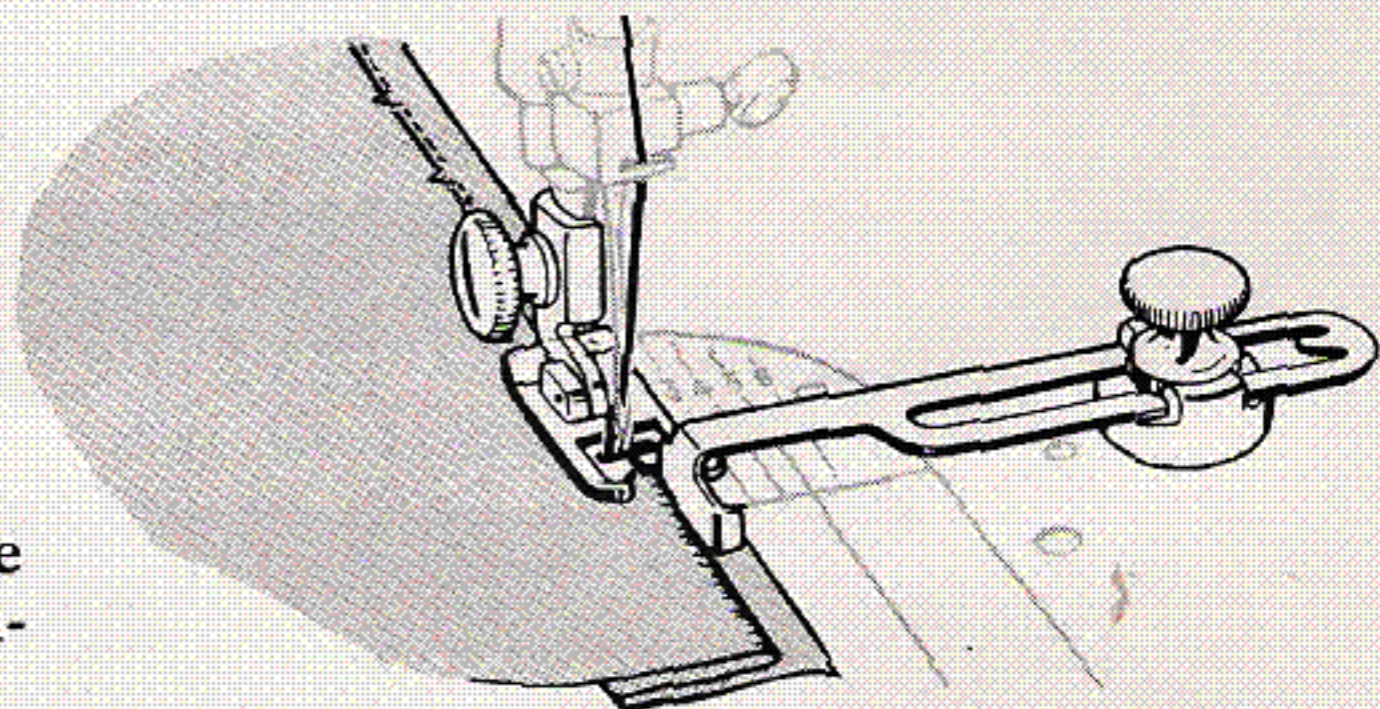
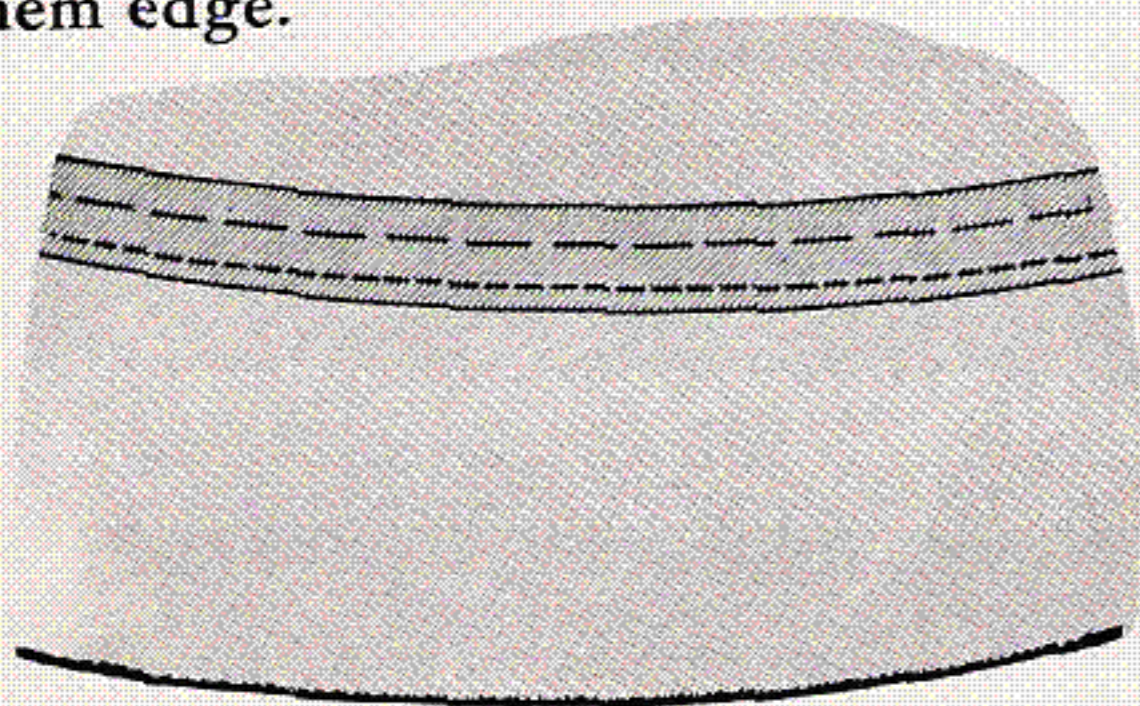

Place hem edge over feed of machine, turn back bulk of fabric to line of basting, thereby creating a soft fold.

Position work so that straight stitches are made on hem edge and sideward stitches pierce the fold.

Adjust seam guide over right toe of foot until it rests next to soft fold. While stitching, feed fold against flat of guide.

A test sample should be made to determine stitch width and stitch length for weight and texture of fabric used.

## THE FOOT HEMMER

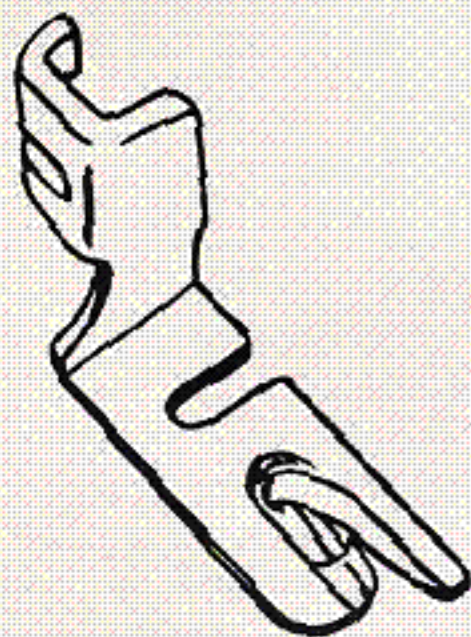

The narrow hemmer forms and stitches a perfectly turned hem without basting or pressing. It is attached to machine in place of regular presser foot.

## APPLICATIONS

Fine Hems

Edging Ruffles

Hemmed Seams

Hemming with Lace

Lace Insertion

Lingerie Finishes

STITCH WIDTH: **O**

NEEDLE POSITION: **C**

STRAIGHT STITCH THROAT PLATE

FOOT HEMMER

## HEMMING

Form a double  $\frac{1}{8}$ " fold at edge of fabric; crease fold for about 2". Draw bobbin and needle threads under hemmer. Place fabric under foot and stitch through creased fold for several stitches. Hold thread ends in left hand and guide raw edge in front of hemmer evenly into scroll. Sew slowly, still holding thread ends until hem is well started. Feed material evenly into hemmer scroll.

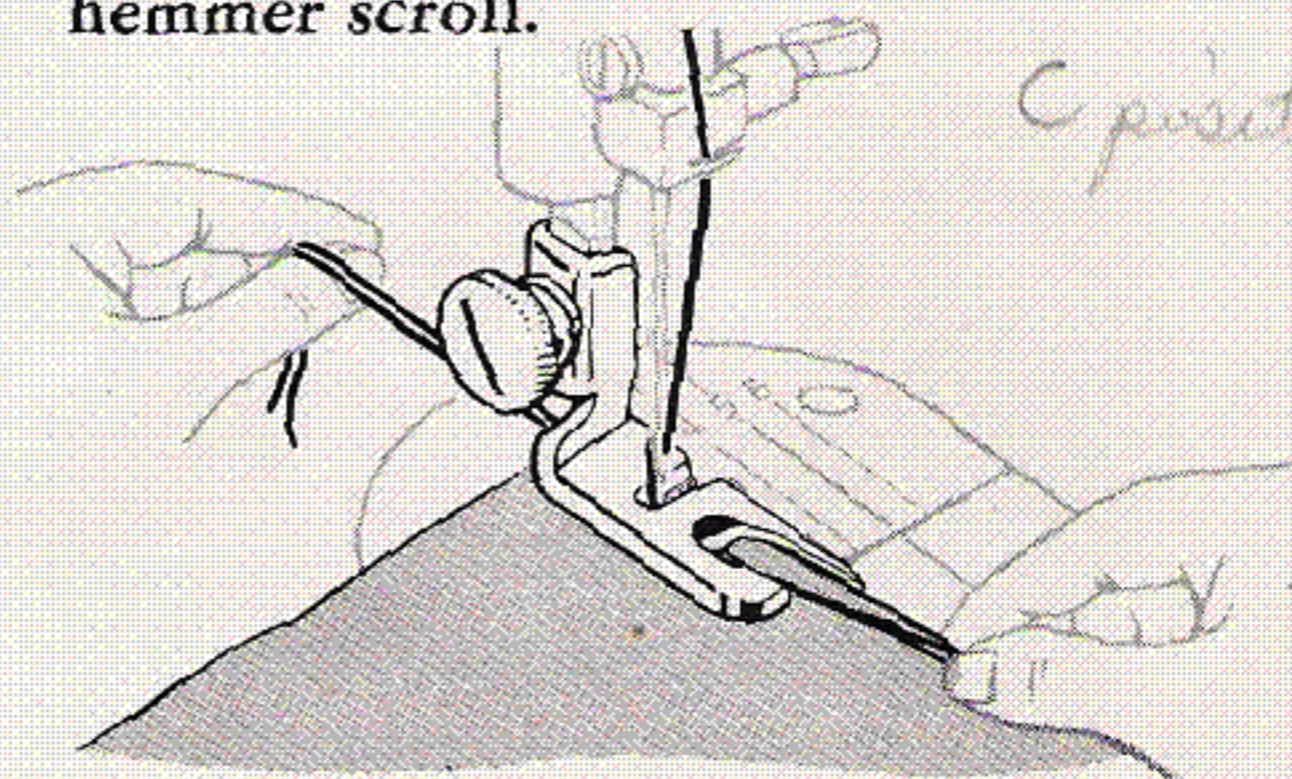

## HEMMED SEAMS

Hemmed seams are appropriate where a fine narrow seam is desired.

- Allow a scant  $\frac{1}{4}$ " seam allowance.
- With right sides of fabric together, place upper layer  $\frac{1}{8}$ " to left of lower layer.
- Insert two fabric edges into hemmer and proceed as for plain hem.

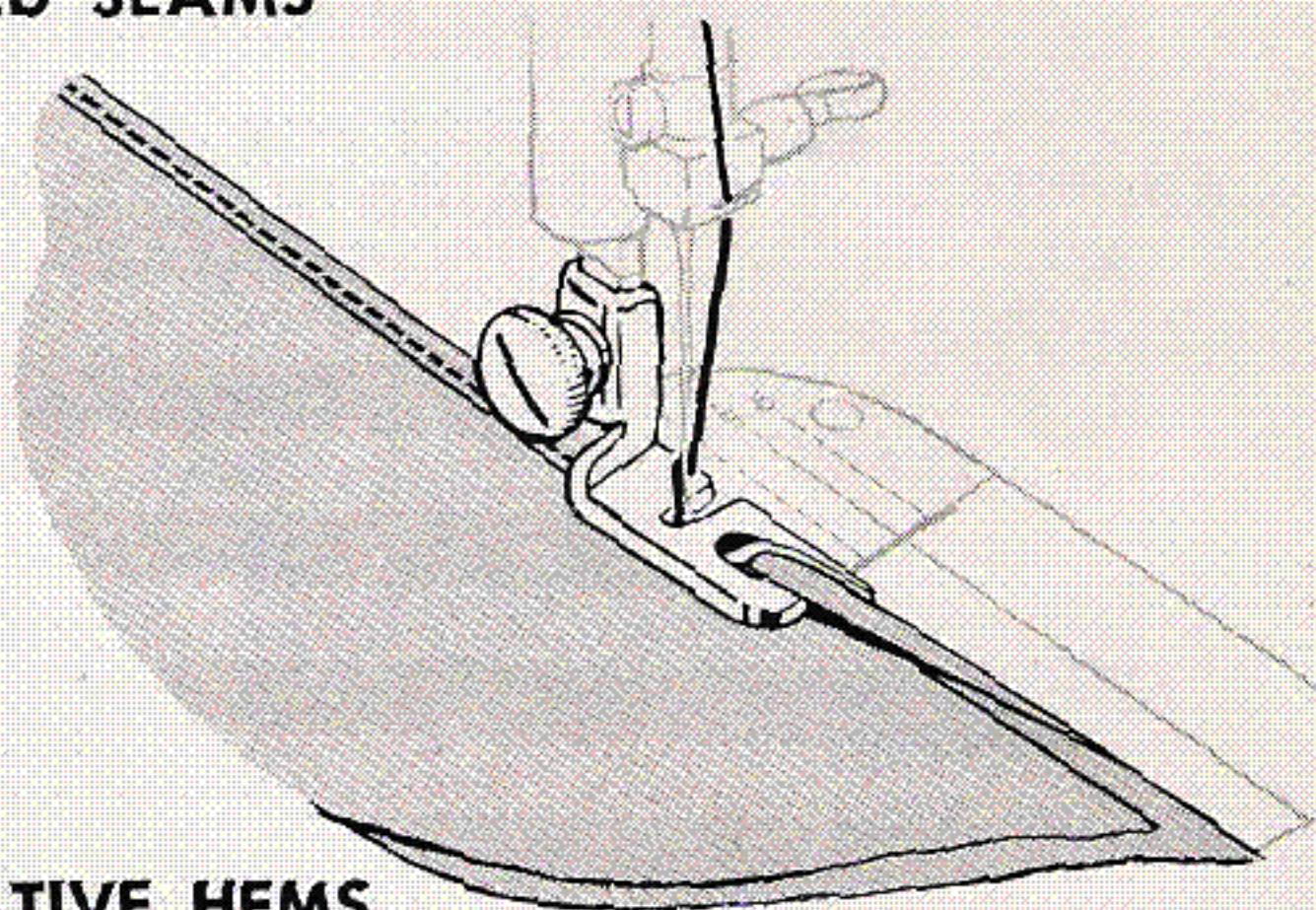

## DECORATIVE HEMS

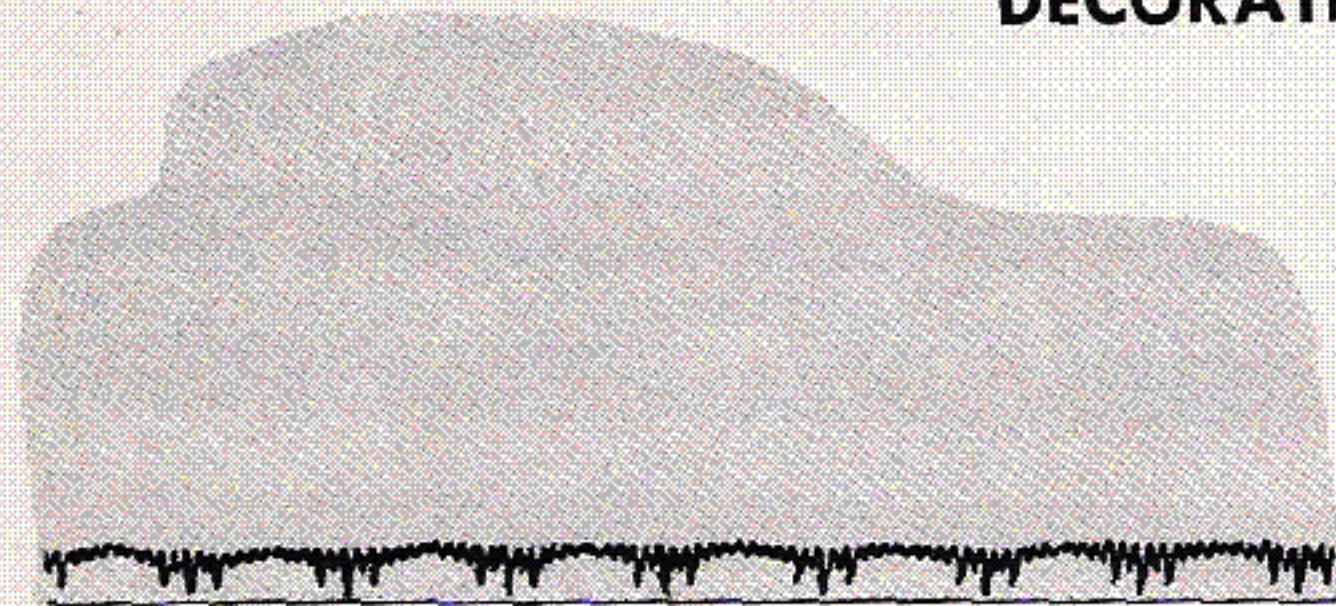

Narrow hem edges can be turned and decorated in one operation using foot hemmer and a stitch pattern.

FASHION DISCS: ALL  
 STITCH WIDTH: 1 THRU 3  
 NEEDLE POSITION: C  
 GENERAL PURPOSE THROAT PLATE

## MULTI-SLOTTED BINDER

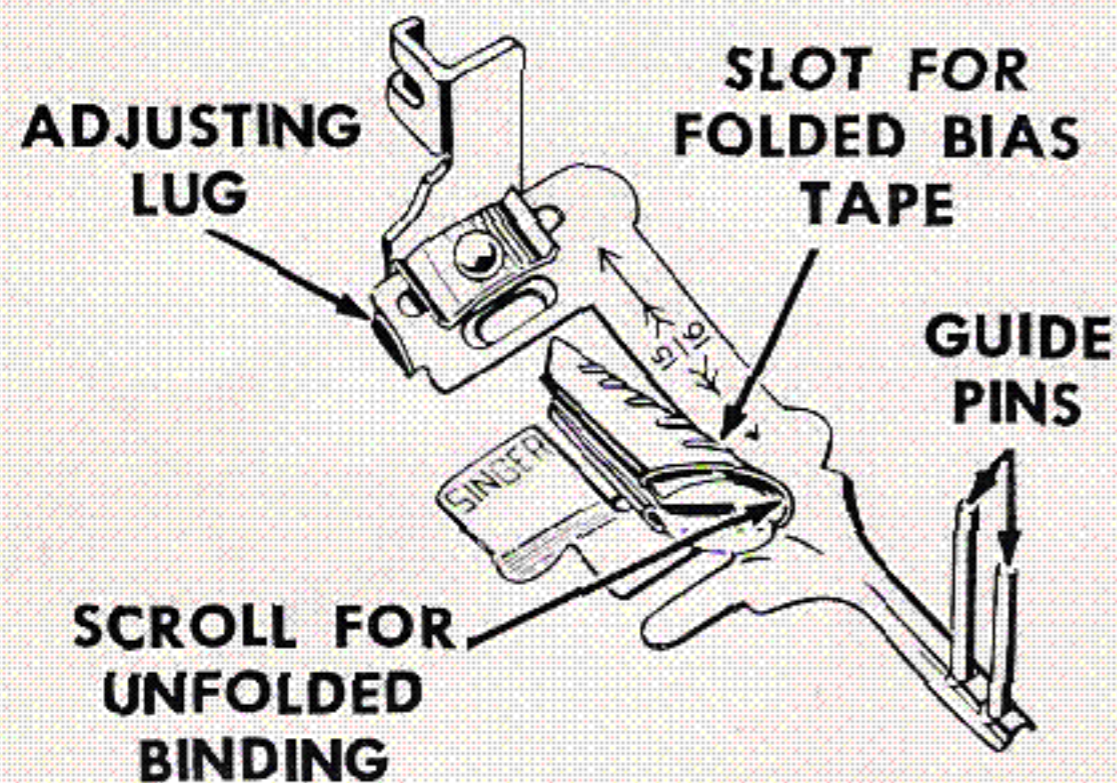

FASHION DISCS: ALL  
 STITCH WIDTH: 0 THRU 4  
 NEEDLE POSITION: C  
 GENERAL PURPOSE THROAT PLATE  
 MULTI-SLOTTED BINDER

Multi-slotted binder is used to apply commercial binding as well as self-fabric bias to an unfinished edge. This colorful trim is attractive when applied to children's wear, aprons and household textiles. It is a practical finish for seam edges that ravel and for making bound seams.

The binder will accommodate both straight and zigzag stitching.

Commercial single fold bias tape is inserted from right into slot at wide end of scroll. Unfolded bias  $15/16$ " wide is inserted into opening at end of scroll.

Cut binding diagonally and pull through scroll until evenly folded edges are under needle. Free length of binding is held between guide pins.

Insert edge to be bound into center of scroll. Position stitching by moving scroll portion of binder to right or left by means of adjusting lug.



## MULTI-SLOTTED BINDER (Cont'd)

Curved edges require slightly different fabric handling from straight edges. Inside curves are straightened as they are fed into binder. If fabric is soft and has a tendency to stretch, reinforce edge with a single row of stitching before binding.

Outside curves tend to lead away from center slot of scroll and should be guided so that a full seam width is taken at needle point. Do not attempt to pull or straighten fabric into full length of scroll.

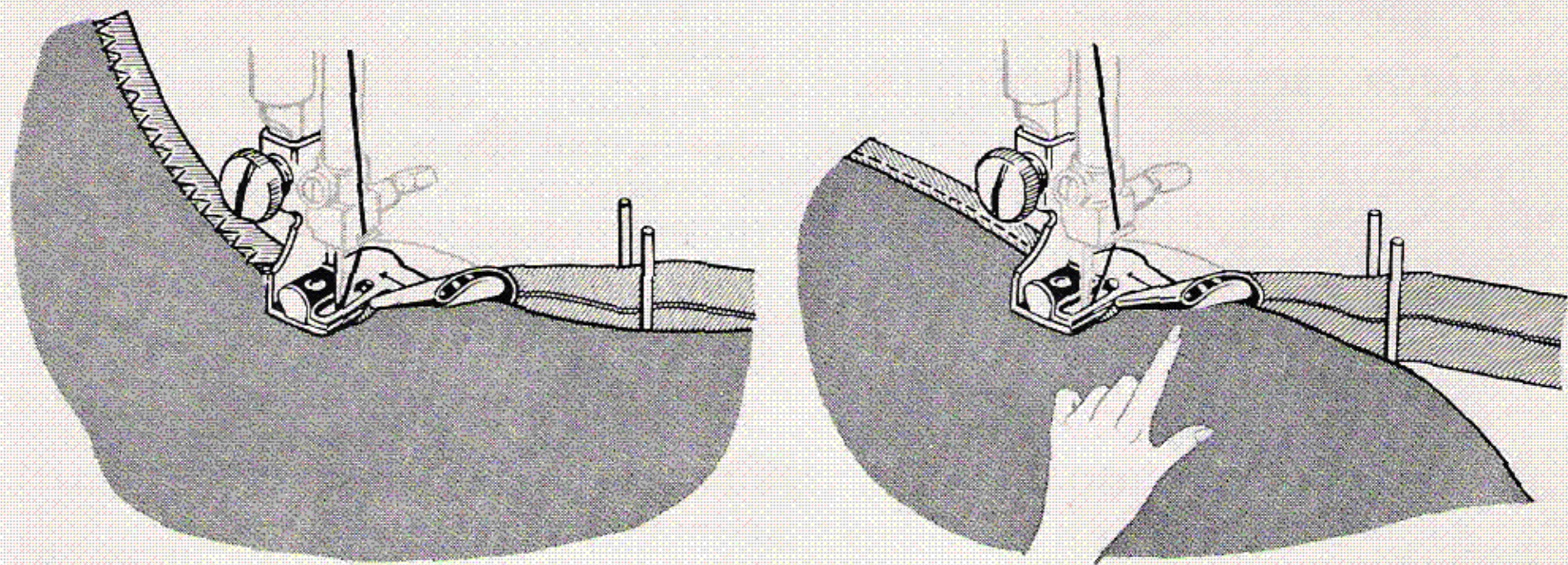

## THE RUFFLER

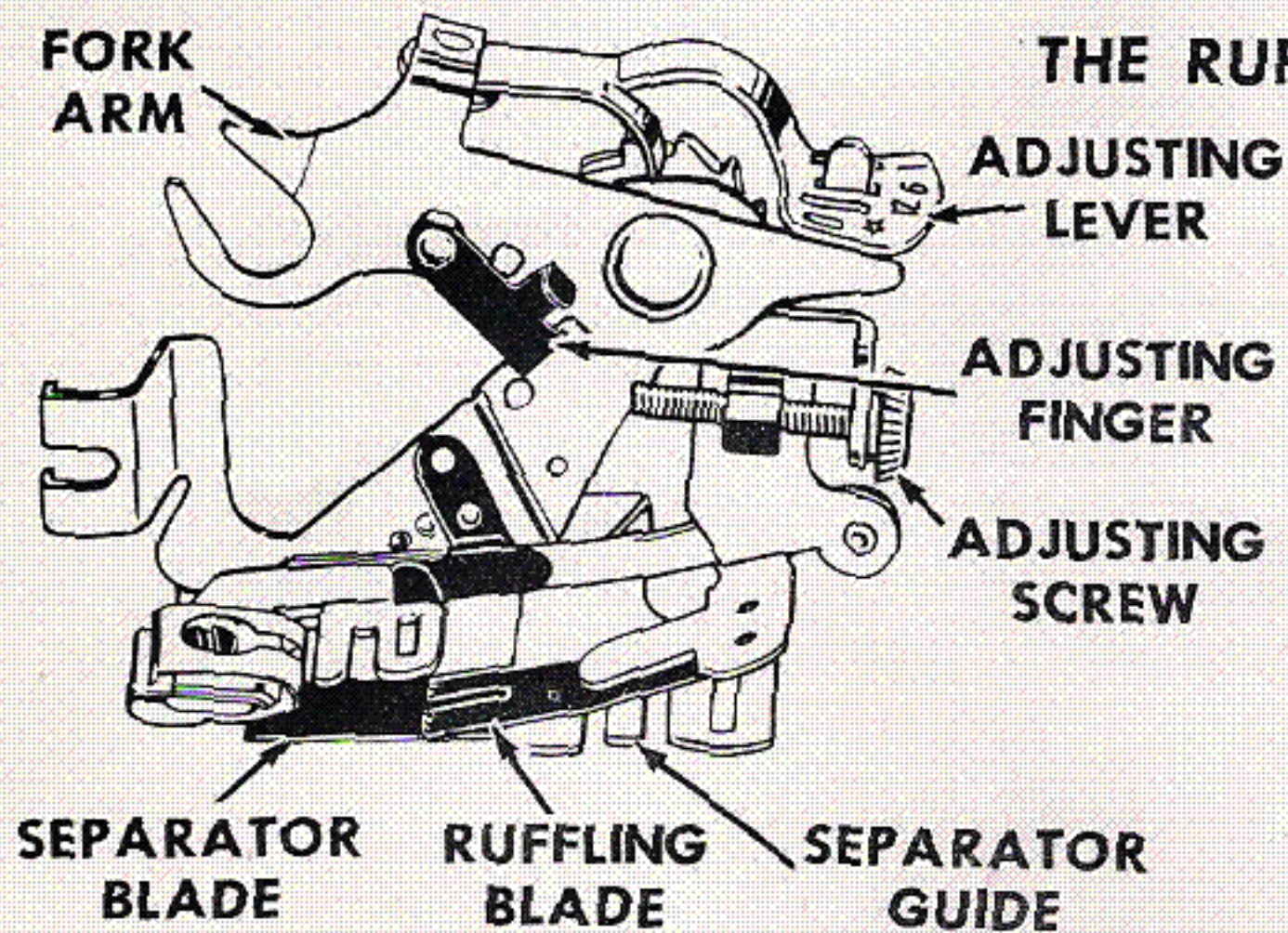

### Adjusting Points

1. Adjusting lever sets ruffler for gathers or pleats. Number 1 space setting is for gathers and places fullness at every stitch. Numbers 6 and 12 are space settings for pleats, spacing them 6 or 12 stitches apart. Star is for straight stitching and is used when grouping gathers or pleats.

2. Adjusting finger is used only for pleating and affects width of pleat. It is disengaged by bringing it out of contact with adjusting screw.

3. Adjusting screw regulates fullness of gathers or pleats. When turned in to its limit with adjusting finger in place, attachment is set for its deepest pleat. When turned outward to its limit, with adjusting finger out of action, ruffler gives only a hint of fullness.

This attachment offers a simple and effective way to make gathered and pleated ruffles. Ruffles may be made separately or made and applied at the same time.

STITCH WIDTH: 0

NEEDLE POSITION: C

STRAIGHT STITCH THROAT PLATE  
RUFFLER

## THE RUFFLER (Cont'd)

**Activating Parts.** Ruffling blade and separator blade are of blue steel and hold material to be gathered between them. Ruffling blade forms gathers or pleats by carrying fabric to needle according to spacing and fullness to which ruffler is adjusted. Separator guide is slotted to guide seam edges evenly and to separate ruffled strip from material to which ruffle is attached.

### Preparation

- Raise needle to highest point.
- Locate ruffler on presser bar with fork arm over needle clamp screw. Securely tighten both presser bar and needle clamp screws.

### Gathering

- Set adjusting lever on Number 1 setting and throw adjusting finger out of action.
- Turn adjusting screw for amount of fullness desired and set stitch length to space fullness. Turn screw in for more fullness; turn out for less fullness.

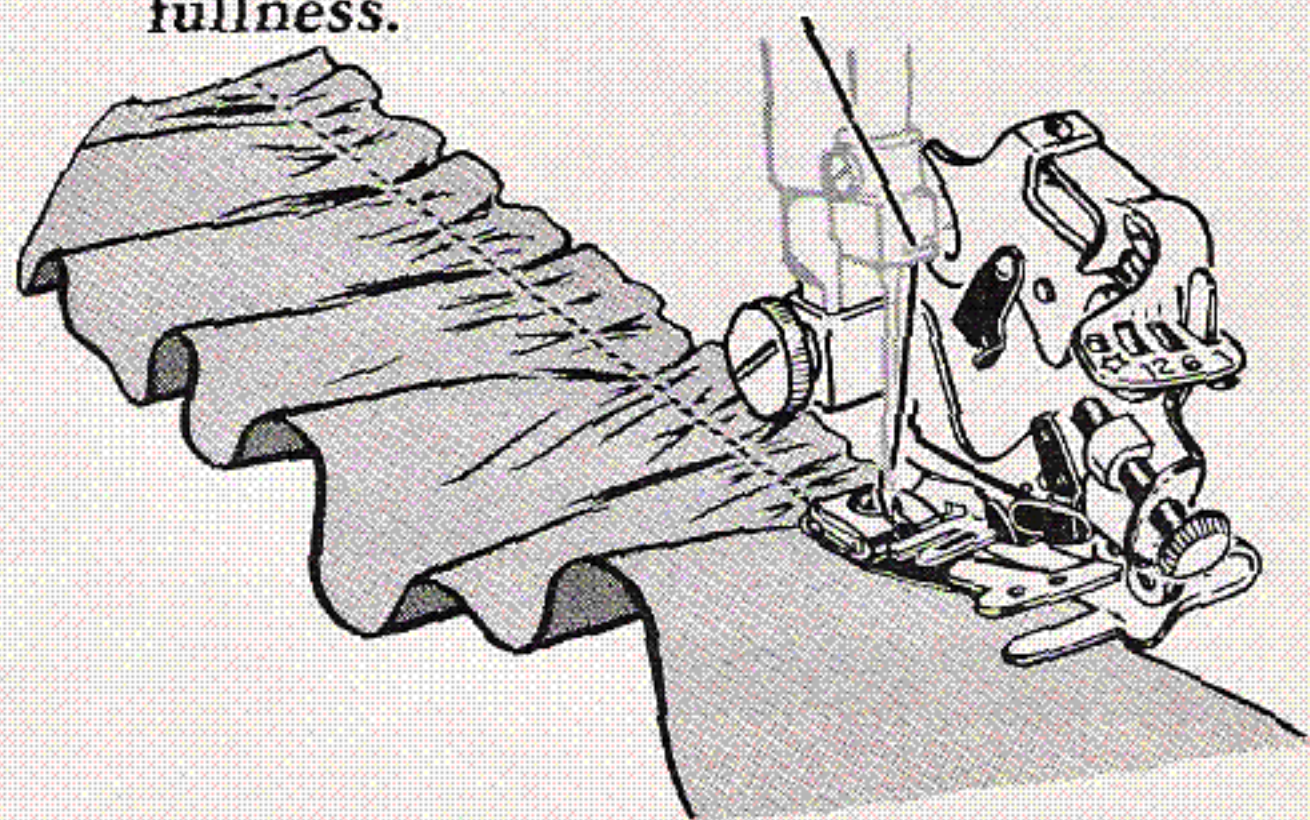

## THE RUFFLER (Cont'd)

Length of sewing machine stitch also affects ruffle fullness. Since a given attachment setting puts an equal amount of fullness into each stitch regardless of its length, shortening the stitch (more stitches to inch) makes ruffle fuller; lengthening the stitch (fewer stitches to inch) makes it less full. For fine, closely spaced gathering, use a short stitch and an outward adjustment of adjusting screw. For deeper, less closely spaced gathering, turn adjusting screw inward and use a medium length stitch.

- Insert material to be gathered between blue blades and through first separator guide.

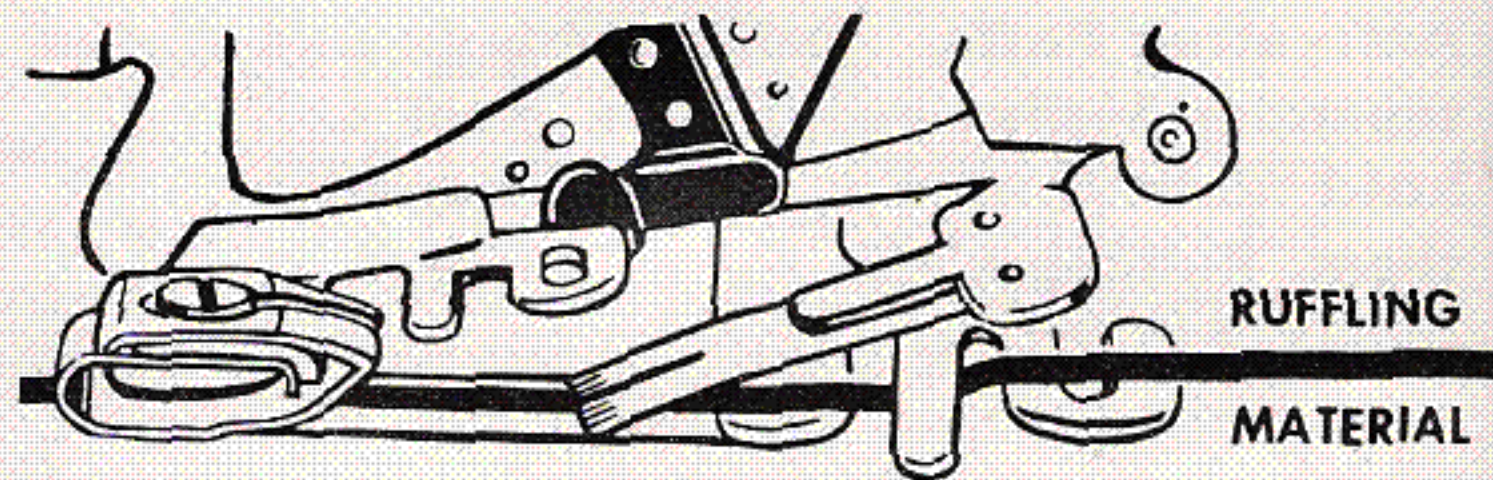

- Draw to back of needle.
- Lower presser bar and stitch.

Fabric texture influences performance of ruffler as well as results. Soft fabrics, cut on crosswise grain, are best adapted for gathering ruffles. Always test stitch length and ruffler setting on a scrap of self-fabric before proceeding with the actual work.

## THE RUFFLER (Cont'd)

### Attaching ruffle

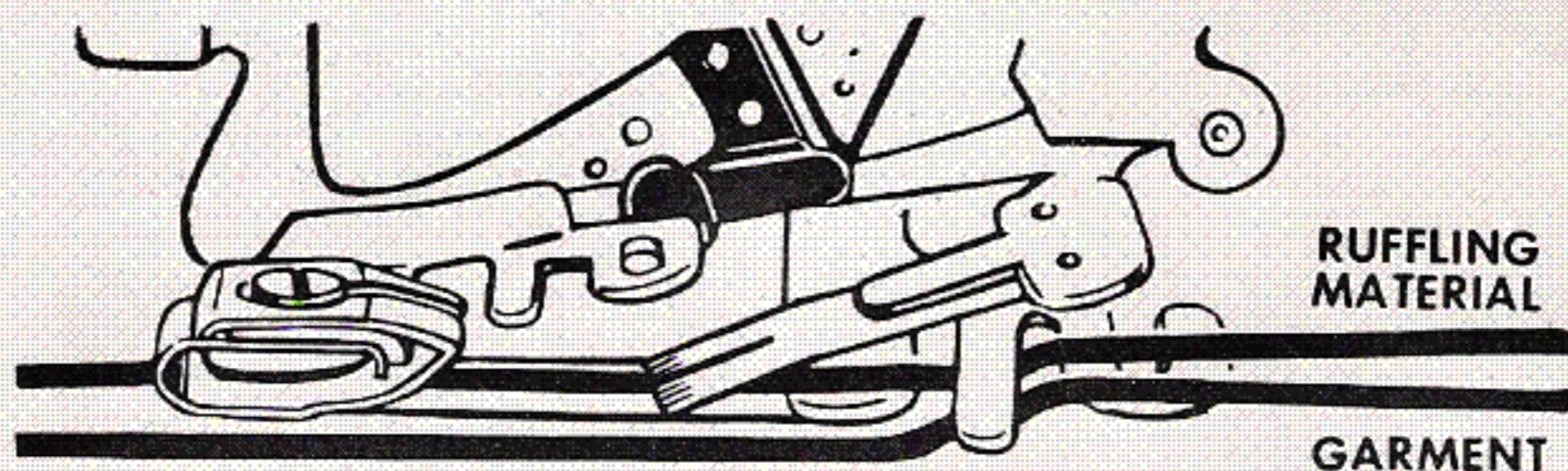

- Place ruffle strip between two blue blades and through first separator guide.
- Place material to which ruffle is to be attached between separator blade and feed of machine.
- Proceed as for plain gathering.

Right sides of fabrics are placed together when the seam is to fall to the inside.

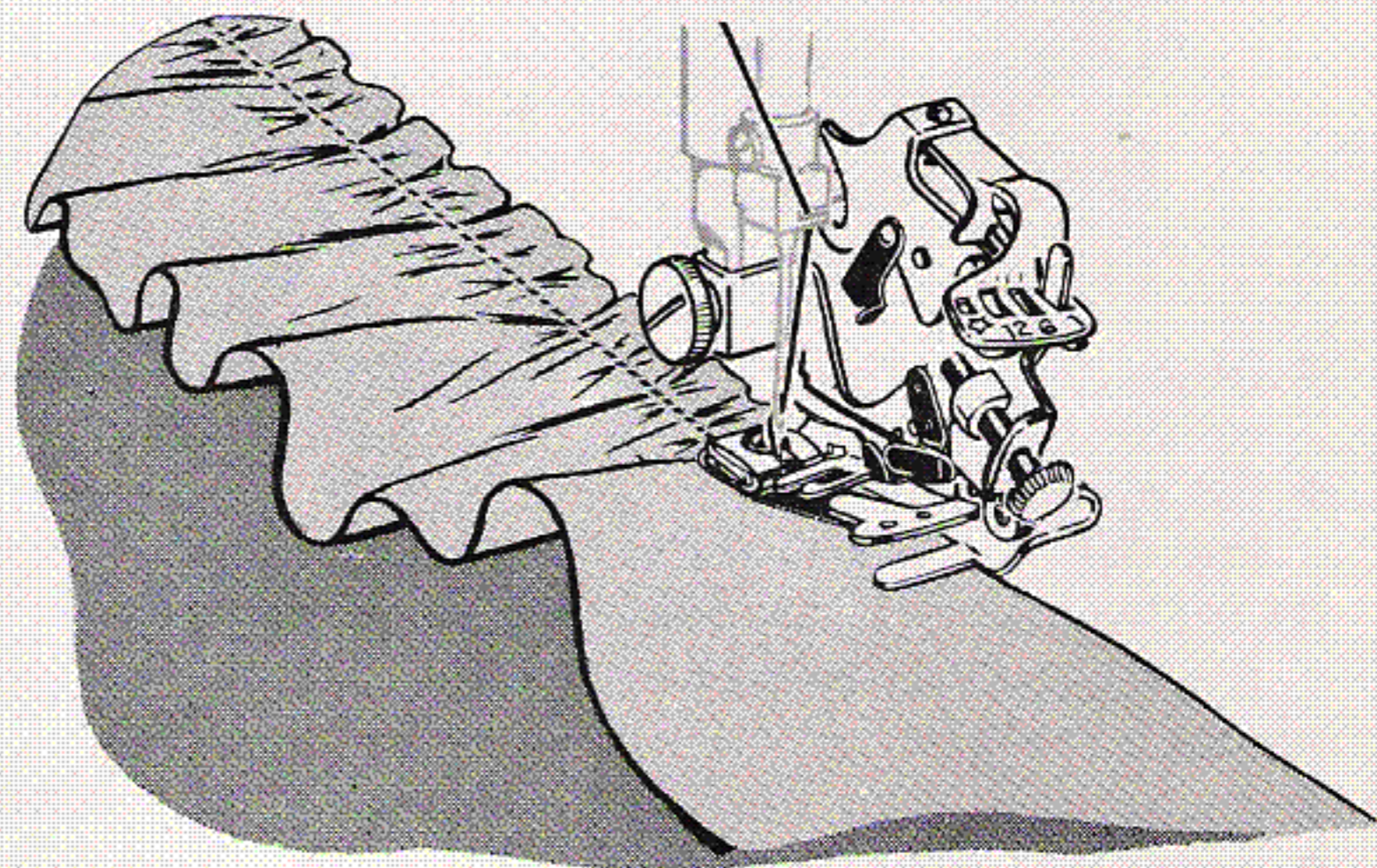

## THE RUFFLER (Cont'd)

### *Pleating*

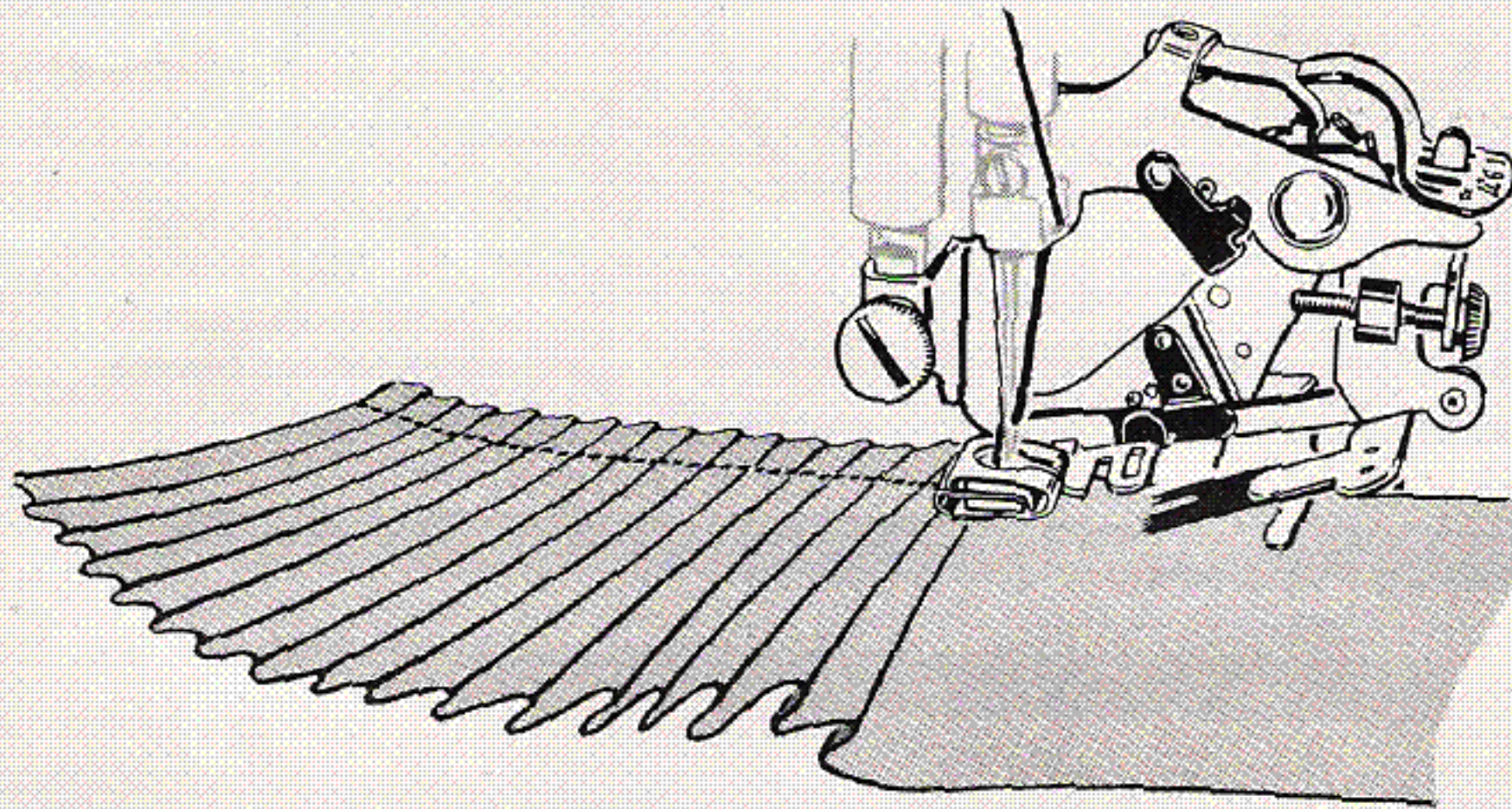

- Move adjusting lever of ruffler to desired space setting for pleats either 6 or 12 stitches apart.
  - Set stitch length.
- For deepest pleat, activate adjusting finger and turn adjusting screw inward to its maximum setting. For smaller pleats turn adjusting screw outward.
- A short stitch places pleats more closely together; a long stitch separates the pleats for a greater distance.
- Insert fabric to be pleated between blue blades and into first separator guide.
  - Lower presser bar and stitch.

## THE RUFFLER (Cont'd)

Crisp fabrics cut on the crosswise grain form the sharpest pleats. Glazed fabrics handle best if the glazed side is downward and the soft backing is next to the ruffler blade.

### **Group Pleating**

By using star setting (straight stitching) alternately with 6 or 12 stitch setting, pleats are formed in groups. Even spacing between groups is accomplished by counting the number of stitches.

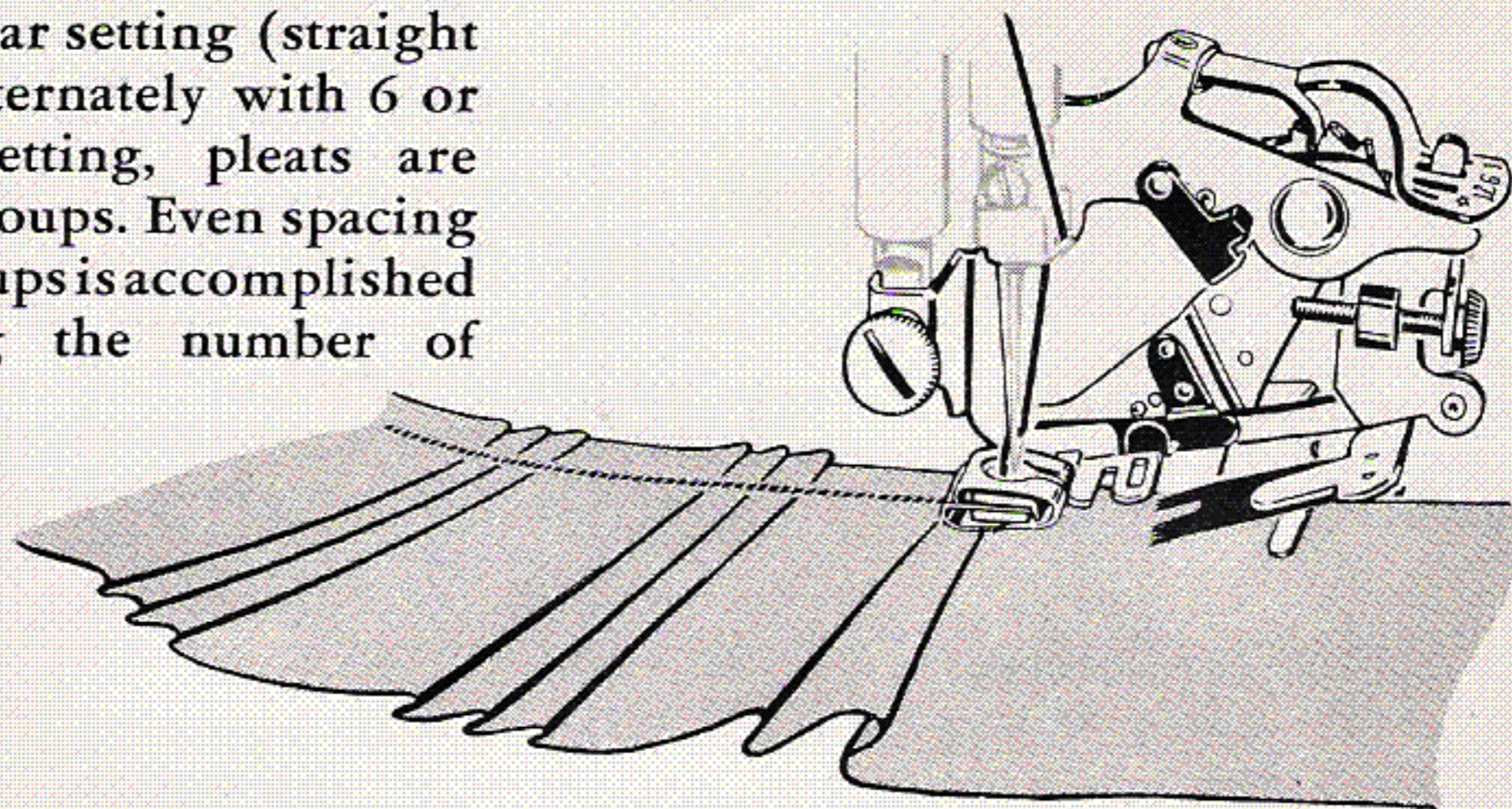

## FREE MOTION WORK

### Darning

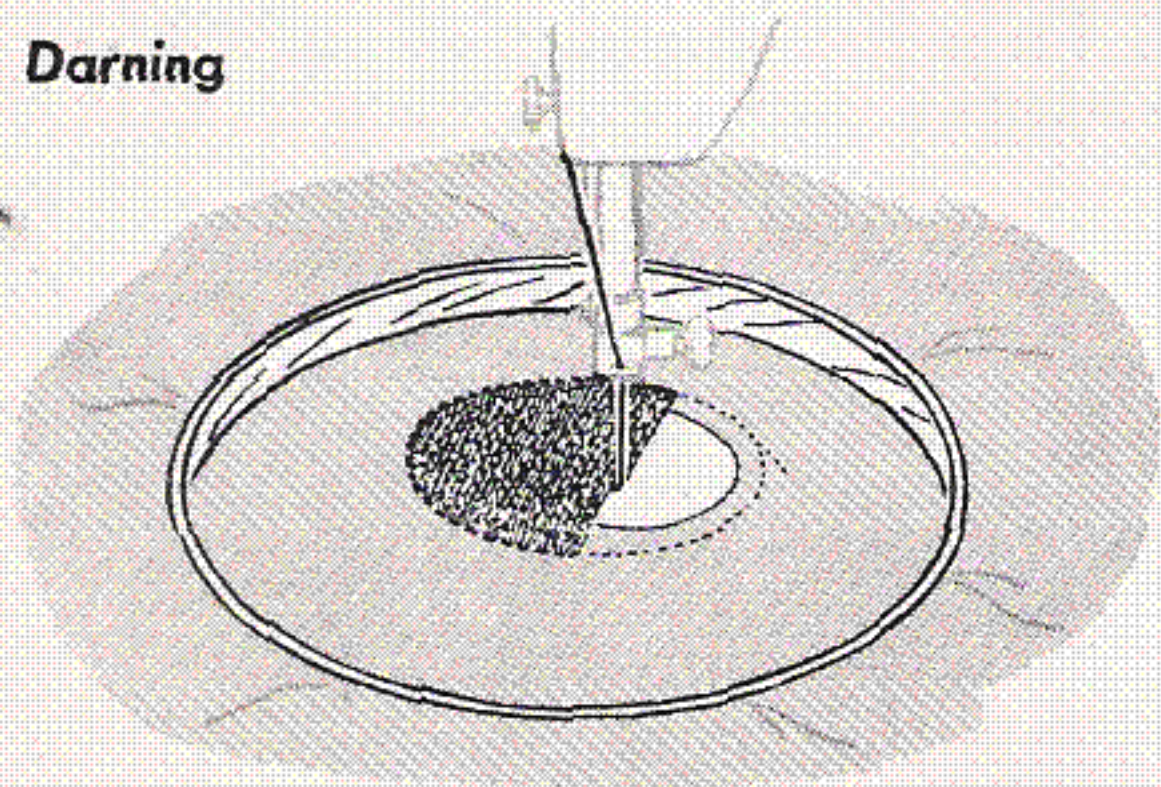

Household linens, children's clothes and knit wear of all kinds can be repaired with the darning stitch.

#### Procedure

- Trim ragged edges from area to be darned. Center worn section in embroidery hoops.
- Remove presser foot.
- Insert lifting plate under throat plate as instructed on **page 46**.

STITCH WIDTH: 0  
 NEEDLE POSITION: C  
 STRAIGHT STITCH THROAT PLATE  
 WITH LIFTING PLATE  
 STITCH LENGTH: ABOVE 20

- Position work under needle and lower presser bar to engage tension. Hold needle thread loosely with left hand, turn hand wheel over and draw bobbin thread up through fabric. Hold both thread ends and lower needle into fabric.
- Outline area to be darned with running stitches for reinforcement. Place stitches  $\frac{1}{4}$ " from edge of open area.
- Stitch across opening, moving hoops under needle at a slight angle from lower left to upper right. Keep lines of stitching closely spaced and even in length.



## FREE MOTION WORK

### *Darning (Cont'd)*

- When opening is filled, turn work 90° and continue stitching until darn is completed.
- Run machine at moderate speed and control hoops with a steady continuous movement. Slow movement of hoops will produce a short stitch; more rapid movement lengthens the stitch.

Fairly long stitches are best for knit and tricot fabrics; short stitches are best for cottons and linens as they approximate weave of fabric and are strong enough to withstand many launderings.

Darning and embroidery foot (available for separate purchase) provides a close control of stitch and fabric and aids handling of difficult materials.

### *Embroidery—Monograms*

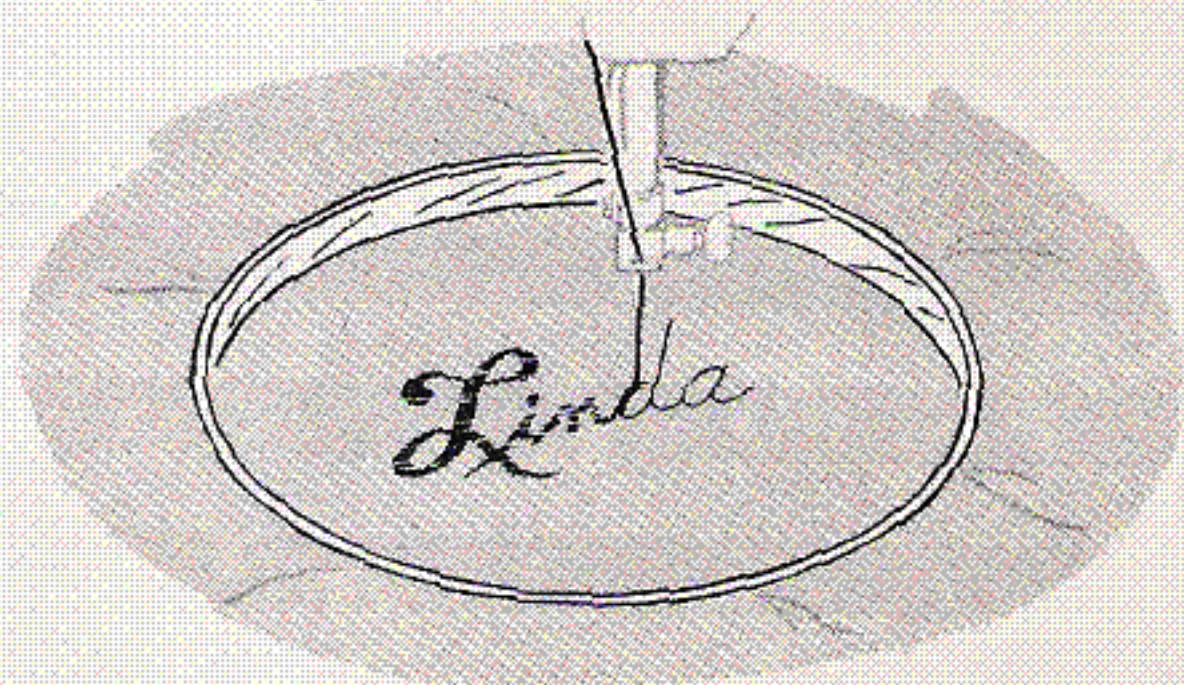

Decorative designs of all kinds can be effectively accomplished with zig-zag stitching when the free motion principle is used.

Design is placed in embroidery hoops to hold fabric taut; hoops are moved slowly so that needle follows outline of design. Stitches are shaded from wide to narrow by controlling angle at which work is placed and moved under needle.

## FASHION\* AIDS

### The Edge Stitcher

This attachment provides a series of slotted guides which regulate the placement of stitching in relation to a fabric edge.

Among many decorative and practical applications are the joining and insertion of lace, tucking from pin width to  $\frac{1}{4}$ ", French seaming, piping, facing and seam finishing.

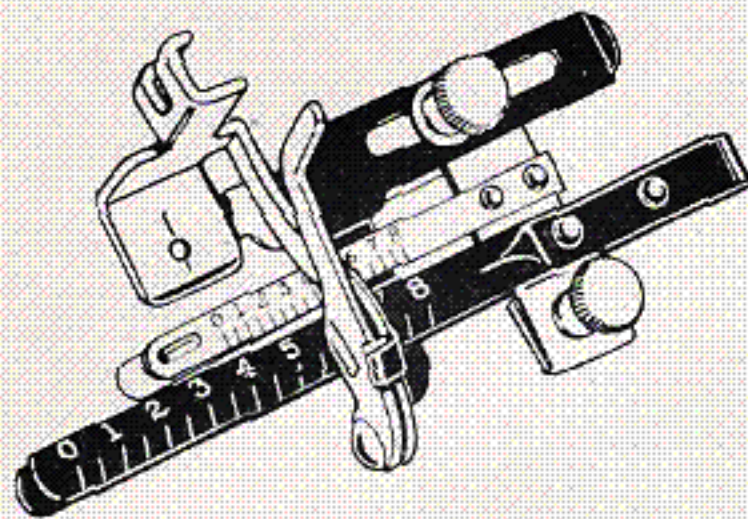
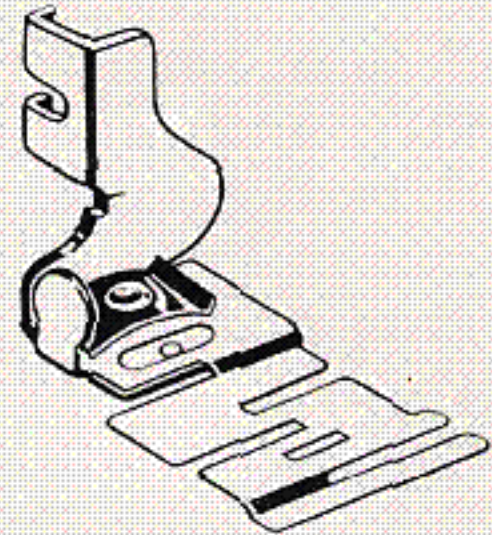

### Tucker

Since the beauty of tucking lies in its explicit accuracy, use of the Tucker will contribute greatly to the attractiveness of the work.

With this time-saving attachment, tucks up to one inch may be stitched and marked in one operation.

Two adjustable scales are provided to gauge tuck width and spacing.

## ADDITIONAL FASHION DISCS

The following additional FASHION Discs are available for separate purchase at your local SINGER SEWING CENTER . . .

4



Scallop

7



Shell Edge

8



Solid Scallop

11



Key

12



Walls of Troy

14



Zigzag Point

15



Long Oblique

16



Shingle

17



Pennant

18



Three Step

19



Ball

20



Curved Mending

21



Thunderbird

22



Semaphore

23



Solid Pyramid

24



Open Pyramid

25



Spiny

26



Block

27



Fagoting

28



Comb

29



Pavilion

30



Platform

## TO CLEAN THE MACHINE

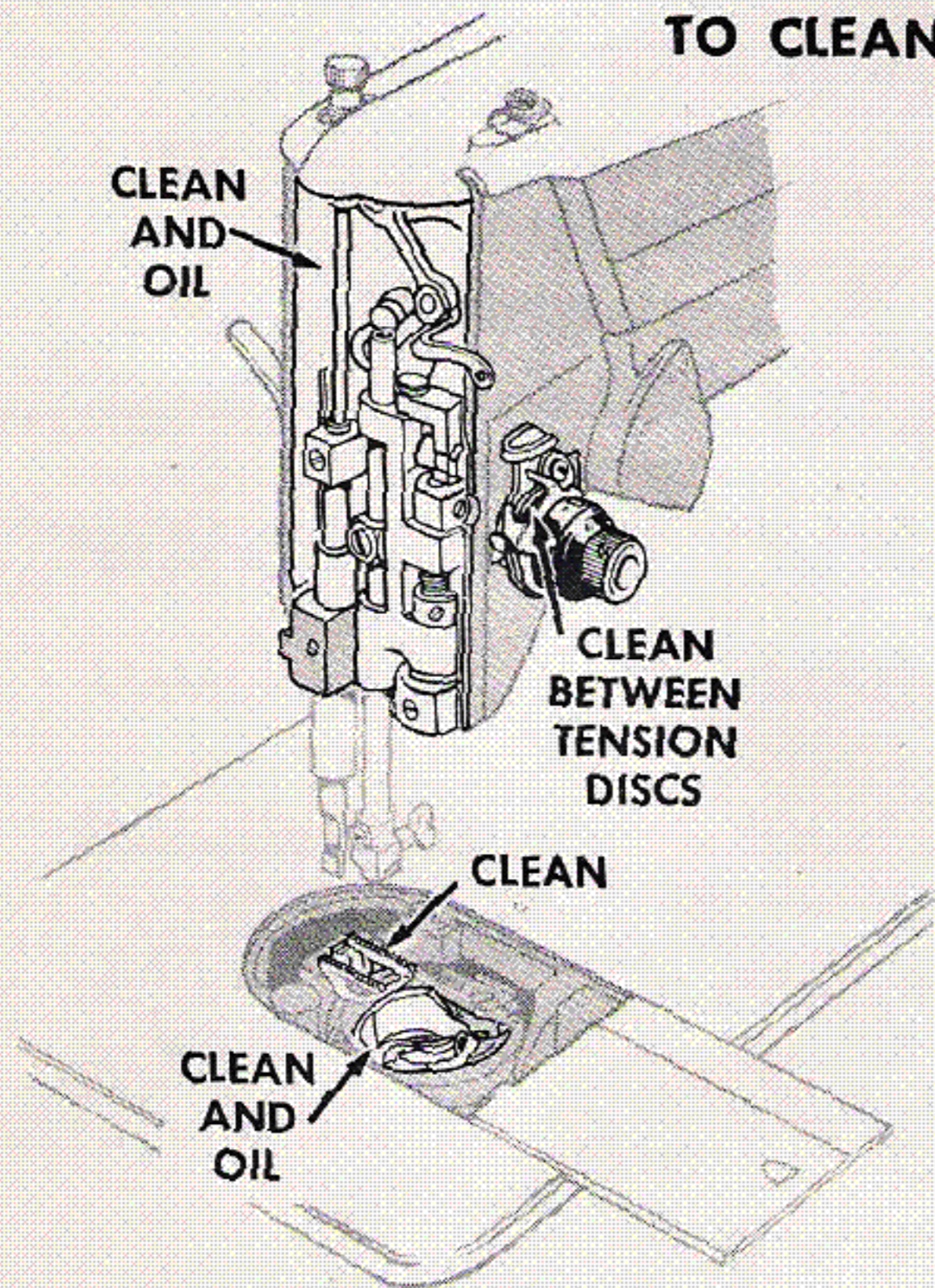

### *When in regular use*

Machine should be cleaned periodically to remove lint and fluff which may have accumulated around working parts. To clean bobbin case area, remove bobbin case as instructed on **page 69**. Oil machine after each cleaning as instructed on **pages 70, 71 and 72**.

### *When stored*

If machine is to be stored away for an indefinite period, a thorough brush-cleaning to remove all traces of lint and fluff, followed by swabbing of all exposed parts with SINGER\* Oil is necessary to protect machine against rust damage.

## TO REMOVE AND REPLACE BOBBIN CASE

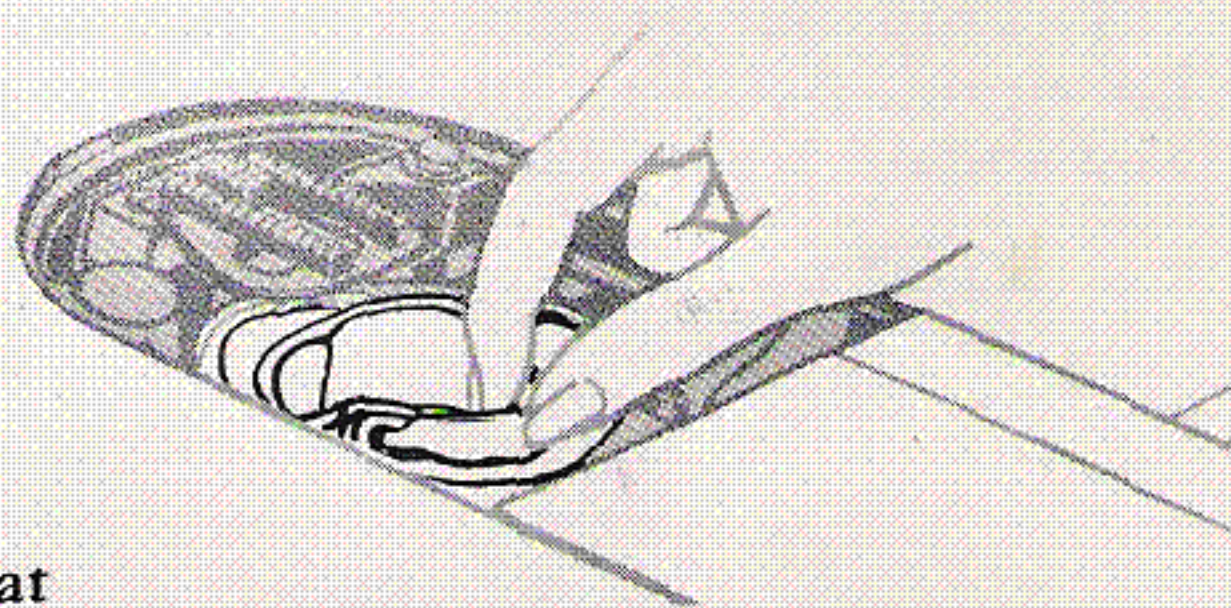
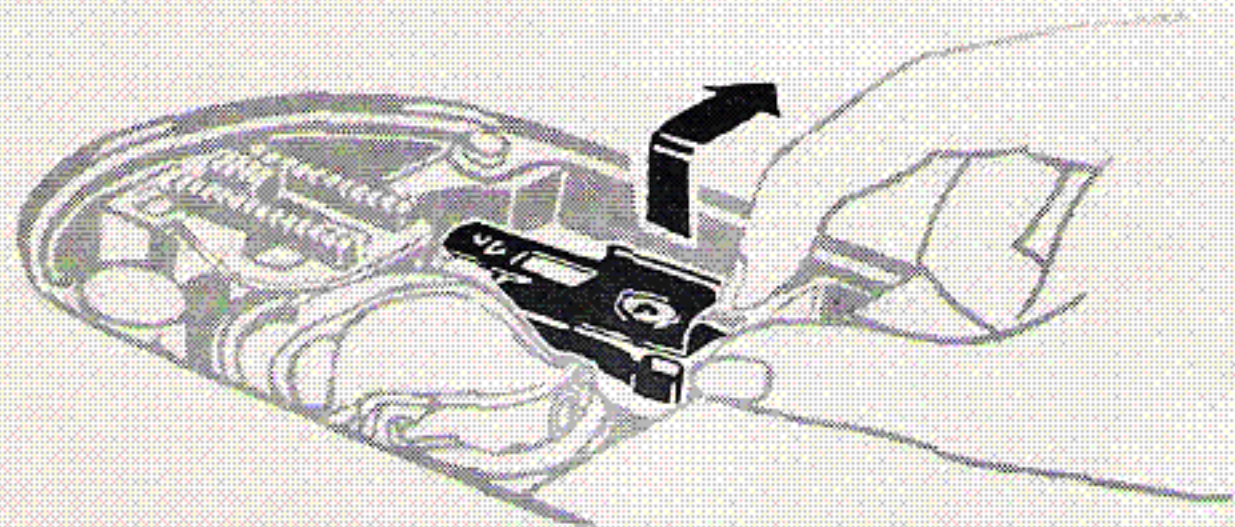

- Open slide plate and remove throat plate (see page 14).
- Unlock bobbin case by lifting and pulling holder to right as shown.
- Remove bobbin case from machine.
- Remove all lint, fluff or other foreign matter which might clog machine.
- Replace bobbin case so that groove under tension spring fits on hook raceway and fork of case straddles positioning stud.
- Push bobbin case holder to left until it snaps down into lock position.
- Replace throat plate and close slide plate.

**POSITIONING  
STUD**

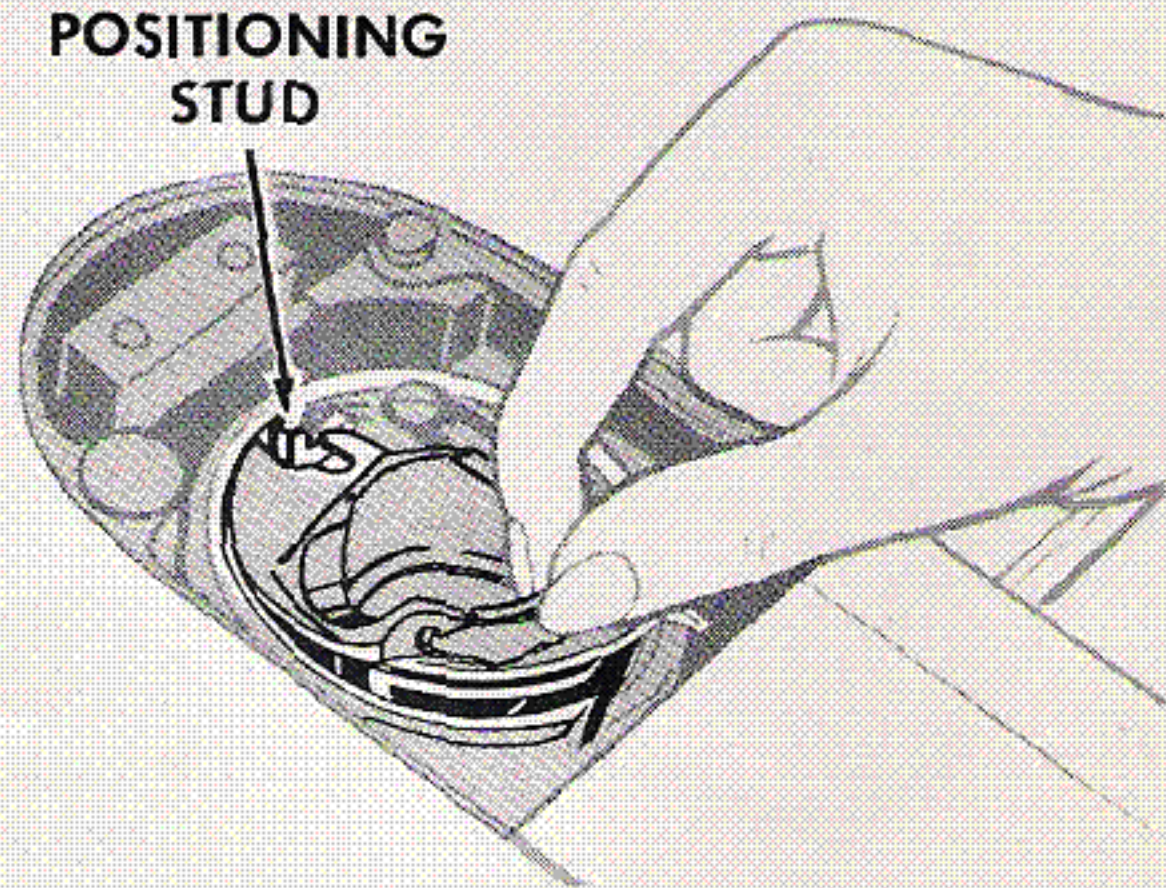

## TO OIL THE MACHINE

To keep your machine in top running condition, use SINGER Oil and SINGER\* Lubricant. Both are quality products especially prepared for sewing machines, and should always be used in the care of your 328.

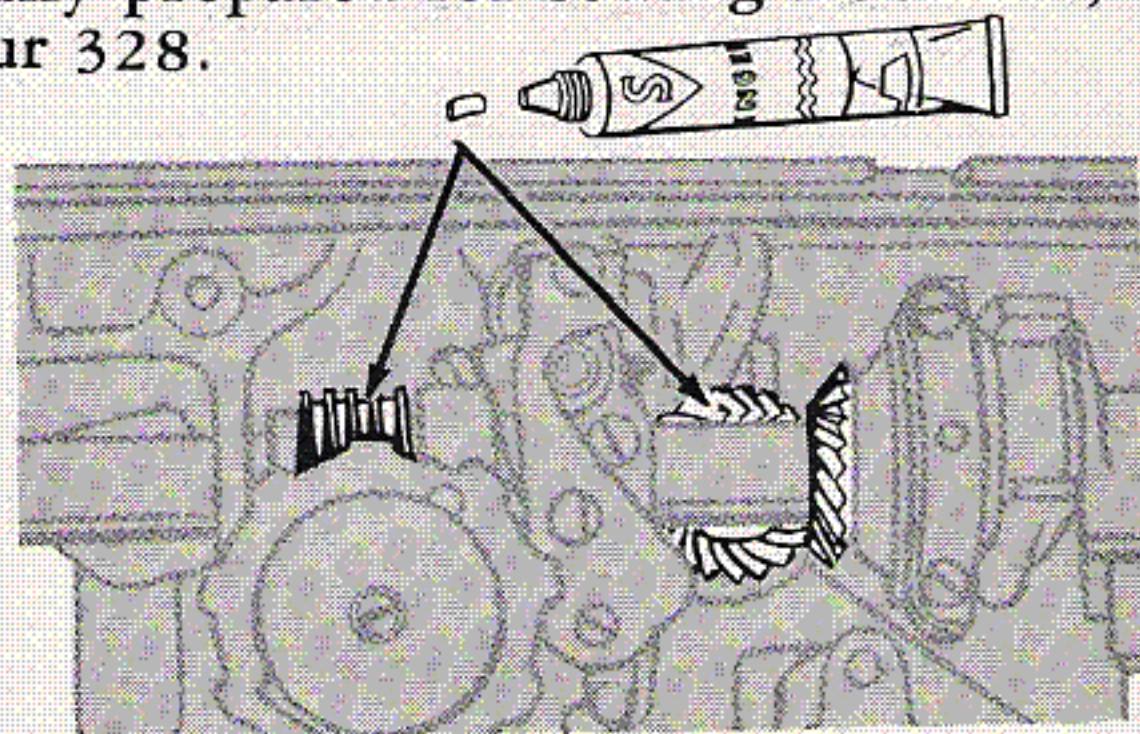
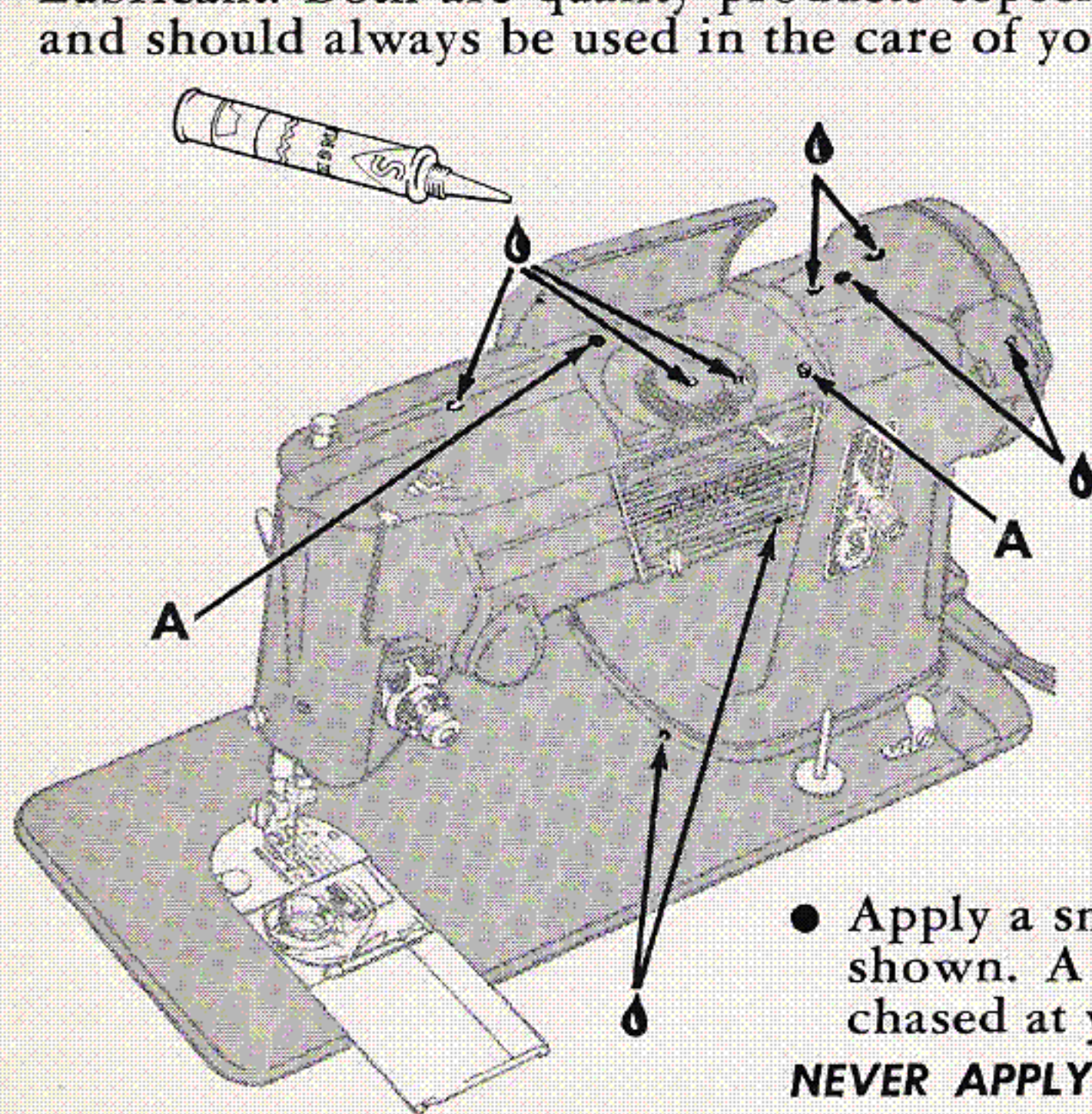

- Clean machine periodically as instructed on **page 68**.
  - Apply a drop of oil to each place indicated.
  - Remove screws **A** and lift off arm top cover.
  - Apply a small amount of lubricant to gears as shown. A tube of this lubricant can be purchased at your **SINGER SEWING CENTER**.
- NEVER APPLY OIL TO GEARS**

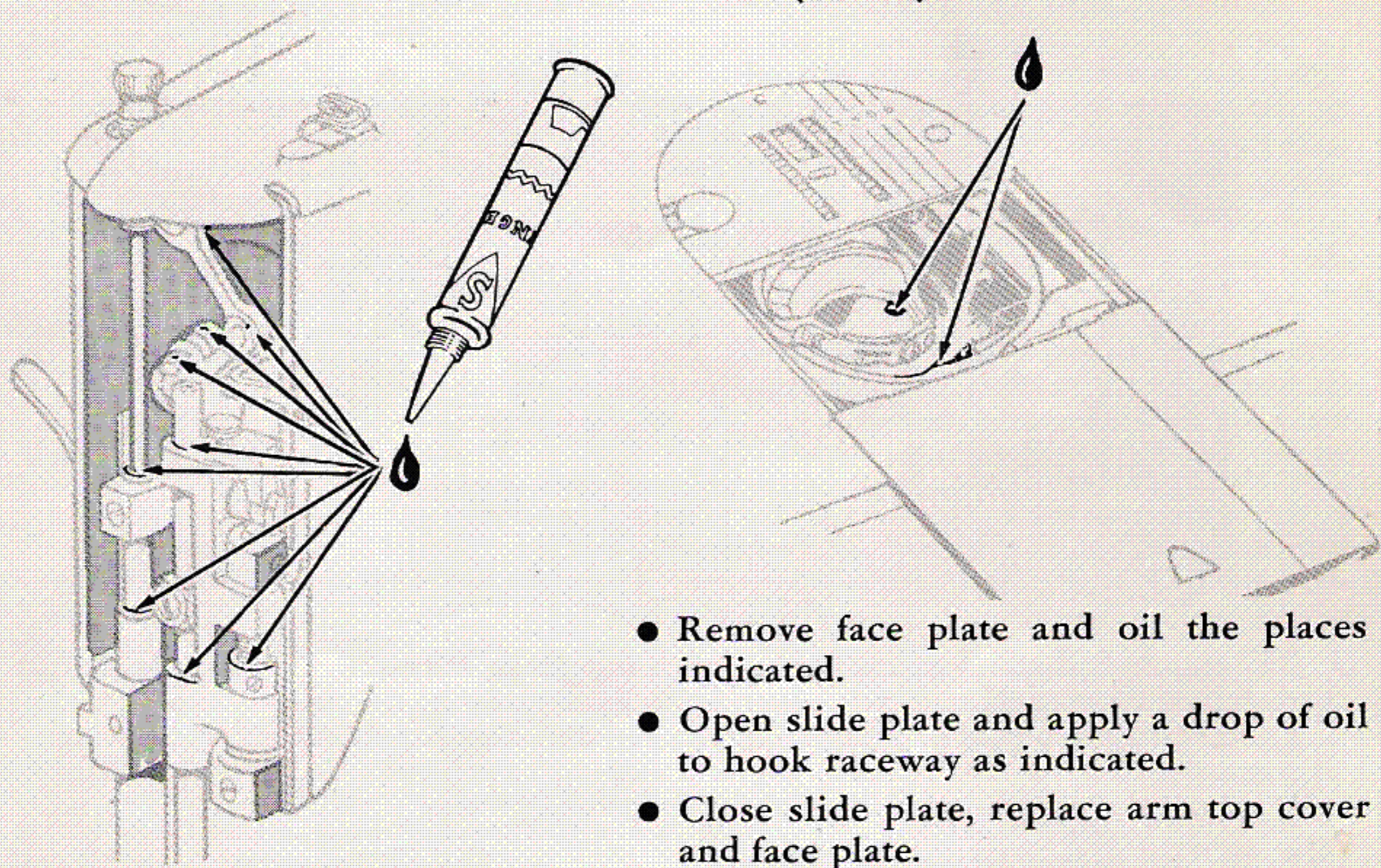
**TO OIL THE MACHINE (Cont'd)**

- Remove face plate and oil the places indicated.
- Open slide plate and apply a drop of oil to hook raceway as indicated.
- Close slide plate, replace arm top cover and face plate.

## TO OIL THE MACHINE (Cont'd)

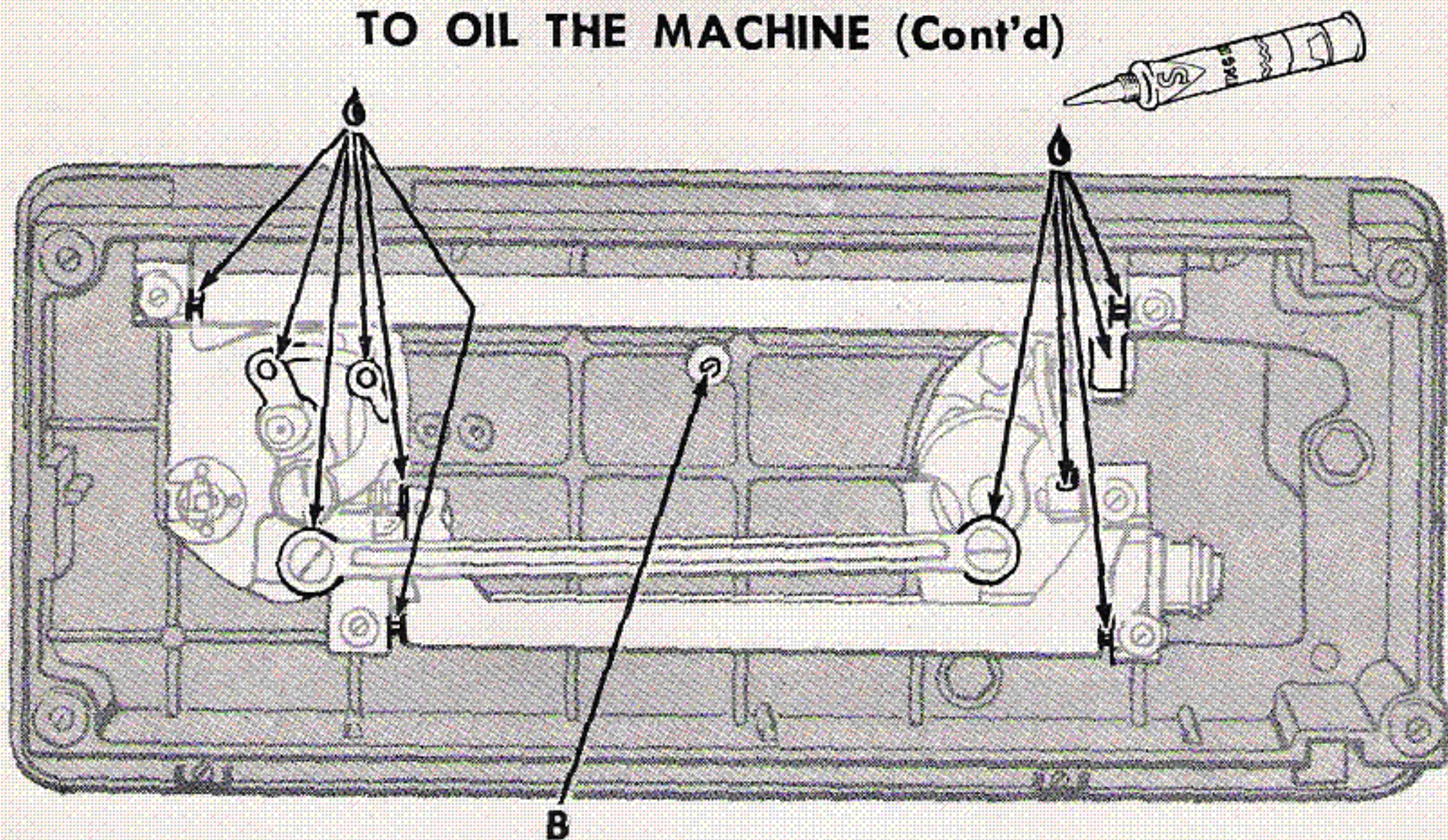

Tilt machine back and remove thumb nut from screw **B**, being careful not to lose felt washer, and remove cover from underside of machine.

Oil each of the places indicated by arrows. Avoid getting oil on any part of the motor.

Replace bottom cover.

**THE MOTOR REQUIRES NO LUBRICATION**



## ELECTRICAL INFORMATION

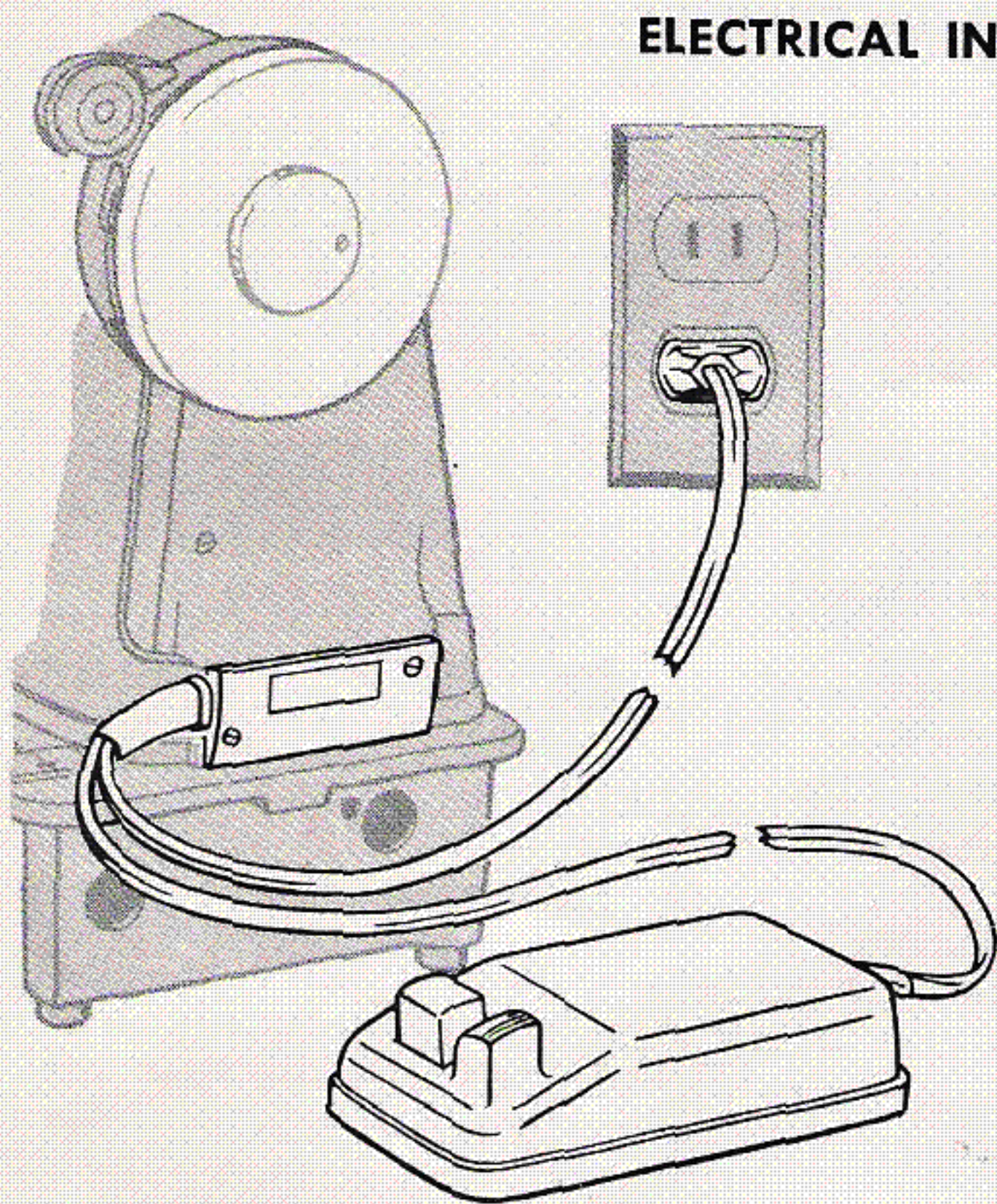

The **SINGER\*** *Electric Motor* in your machine is furnished for operation on an alternating current of 110-120 volts, 50/60 cycles. Special motors are available for direct or alternating current for any voltage between 50 and 145, and for 32 volts direct current.

**Before Inserting Electric Plug,** be sure that voltage and cycles stamped on terminal cover are within range marked on your electrical meter installed by your power company.

**Electrical Connection.** Insert plug into nearest electrical outlet and the machine is ready for operation.

**Speed Controller.** Speed of machine is regulated by amount of pressure on pedal of foot controller or knee lever.

**CAUTION:** Do not attempt to remove the Motor Cover Plate.

## LIGHT

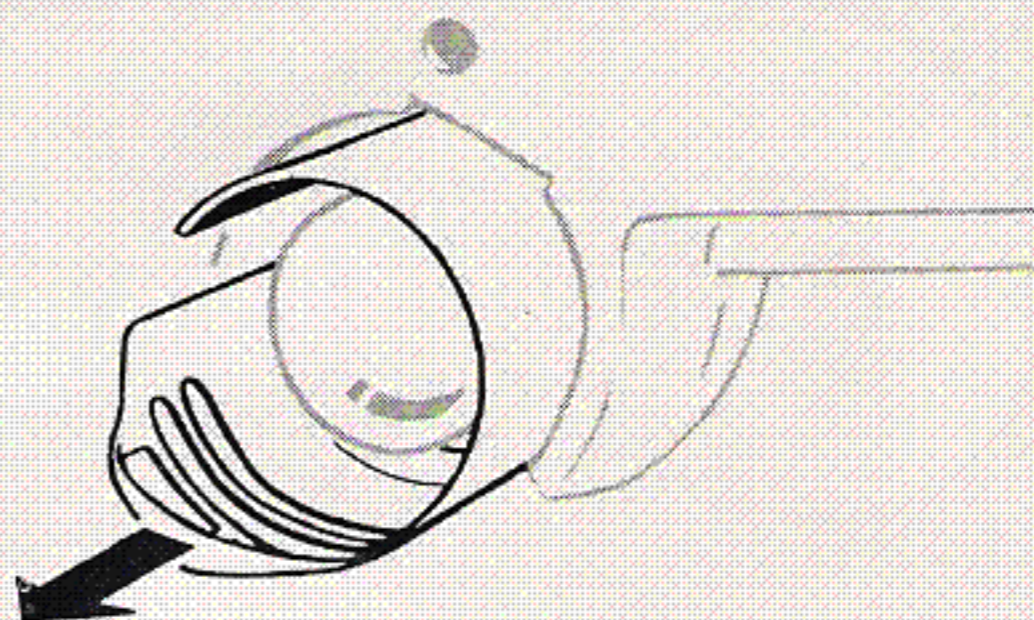
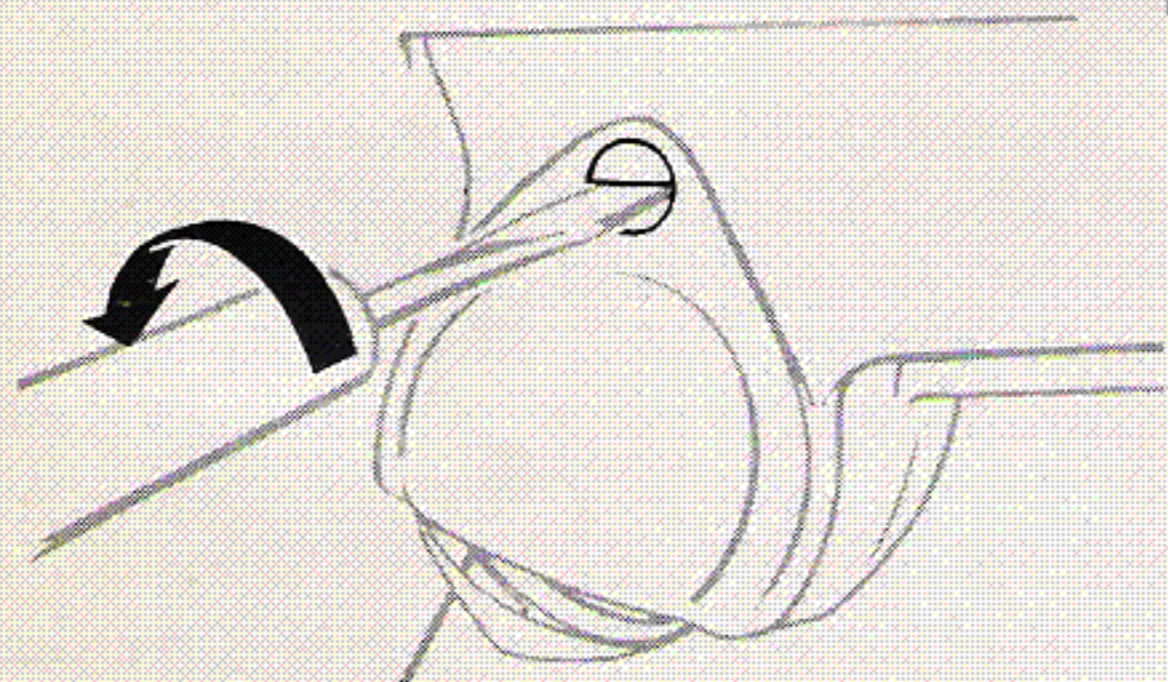

Light turns on automatically when plug is connected to electric outlet.

**To Remove Bulb.** Remove lamp cover screw and remove lamp cover. Pull out light guard.

Do not attempt to unscrew bulb. Press it into socket and turn bulb over to the left to unlock bulb pins. Remove bulb.

**To Replace Bulb.** Press new bulb into socket with bulb pins entering slots of socket. Turn bulb to the right to lock bulb pins in position.

Slip light guard over socket, replace lamp cover and fasten it in position with lamp cover screw.

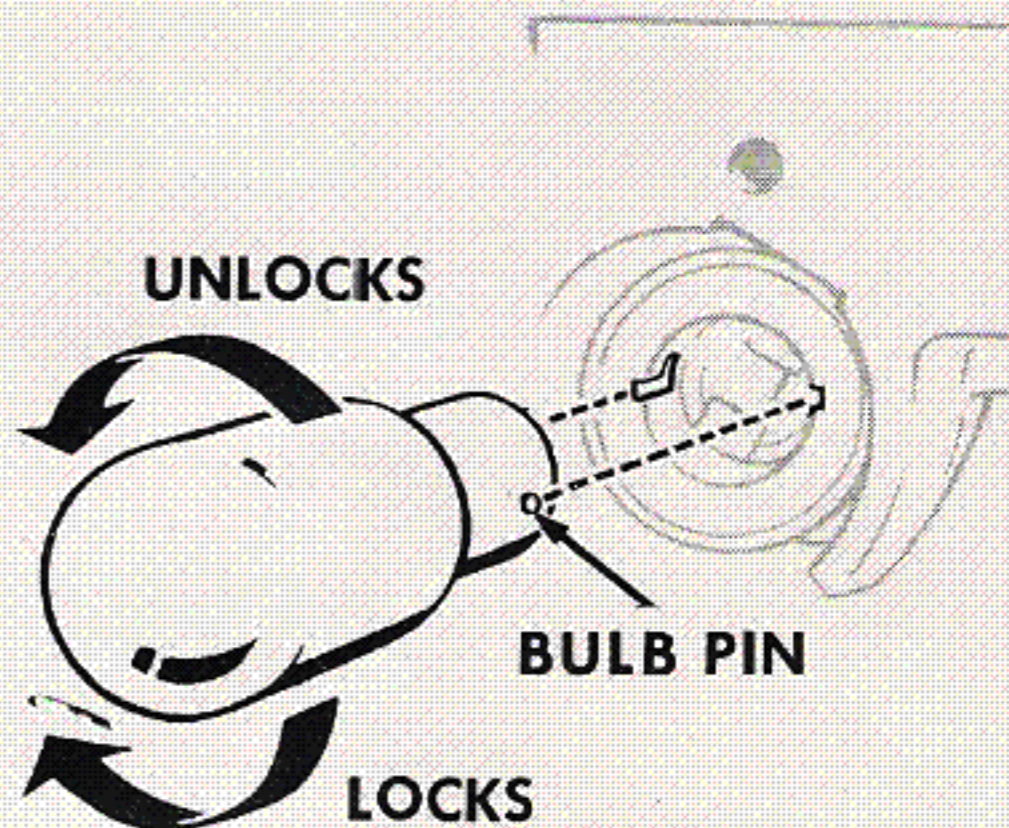

## TO REMOVE AND REPLACE FASHION DISC COVER

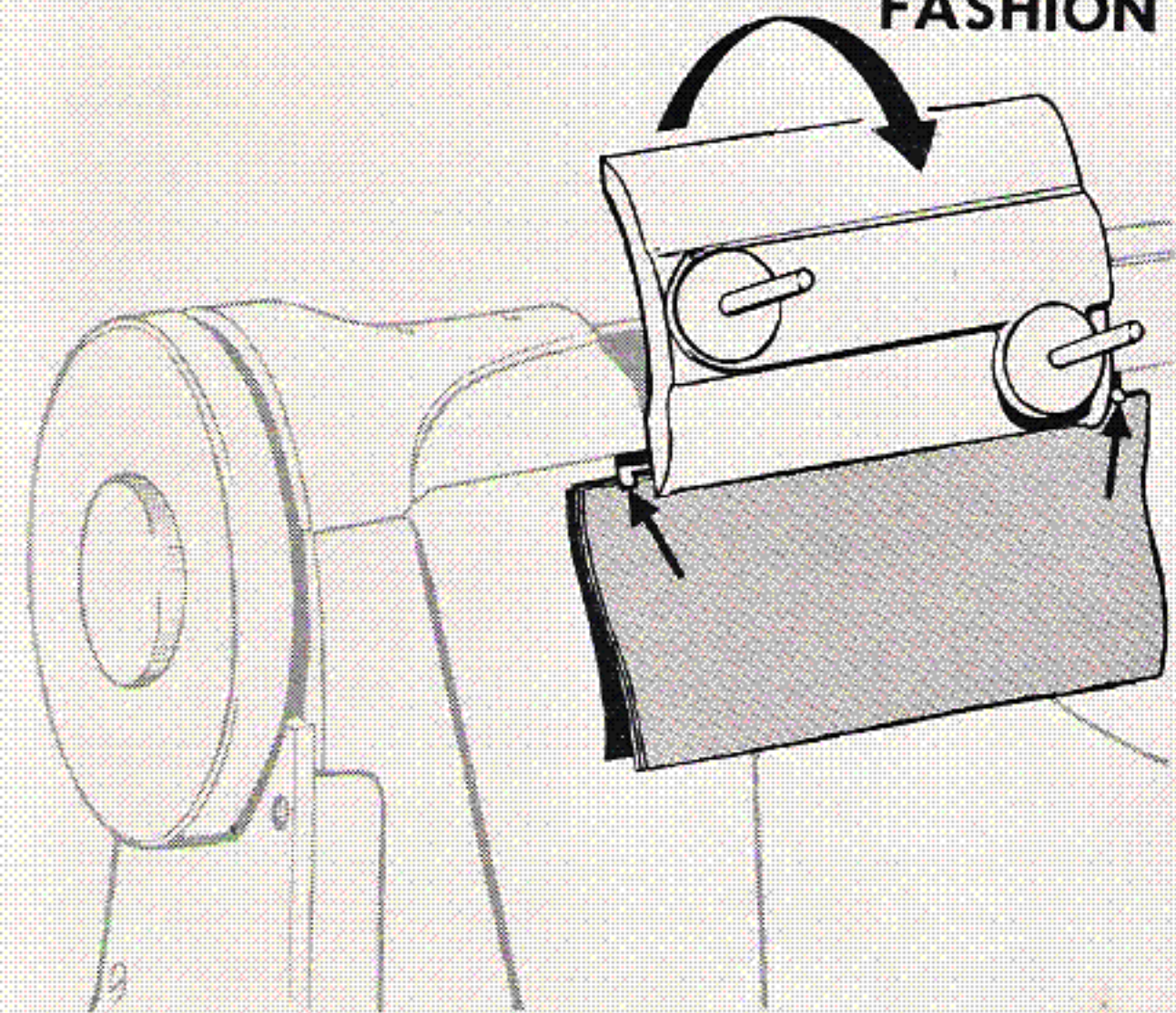

### To Remove

Place several sheets of paper under two springs as shown. Turn cover all the way back until it snaps off. Paper will prevent damage to machine arm during cover removal.

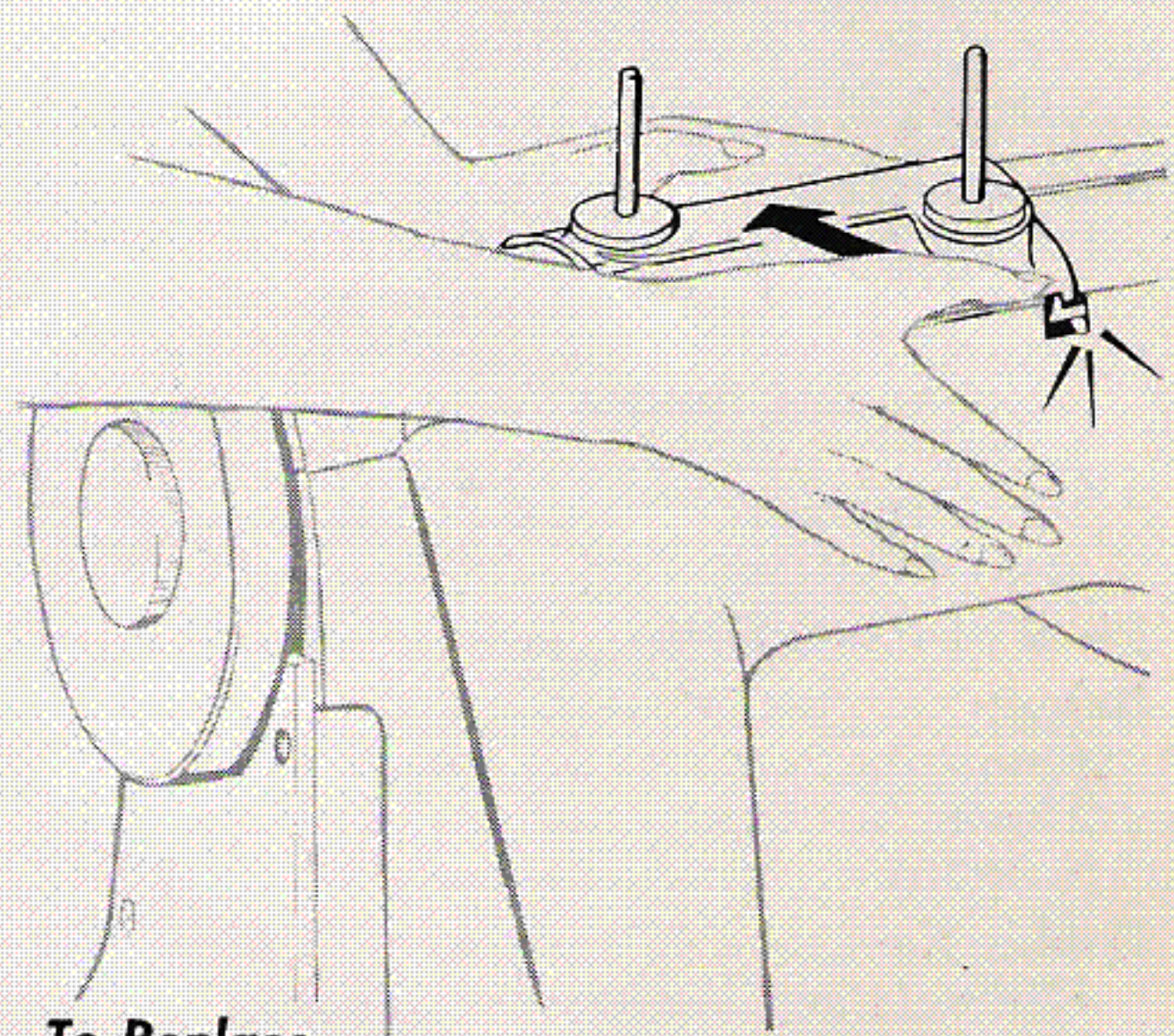

### To Replace

Position cover over arm with lugs resting on top of springs. Push cover in direction shown until it snaps into place.

## INDEX

	PAGE		PAGE
Applique .....	44	Cleaning the Machine .....	68-69
Attachments		Darning, Free Motion Work .....	64-65
Button Sewing Foot .....	46-47	Decorative Hems .....	55
Foot Hemmer .....	54-55	Electrical Information	
General Purpose Foot .....	48-51	Light .....	74
Multi-Slotted Binder .....	56-57	Motor .....	73
Ruffler .....	58-63	Embroidery, Free Motion Work .....	65
Seam Guide .....	52-53	FASHION Aids .....	66
Special Purpose Foot .....	40-45	FASHION Disc Cover	
Blind Stitched Hems .....	53	Removal and Replacement .....	75
Bobbin		FASHION Discs .....	30-31
Removing .....	7	Additional .....	67
Thread Tension .....	25	Removal and Replacement .....	29
Winding .....	8-10	Free Motion Work .....	64-65
Bobbin Case		Gathering .....	59
Removal and Replacement .....	69	Guiding and Supporting Fabric .....	23
Threading .....	11	Length of Stitch, Regulating .....	13 and 34
Buttonholes .....	40-43	Mending .....	51
Button Sewing .....	46-47	Monograms and Motifs .....	45
Chart for Fabric, Thread, Needle and Stitch Length .....	5	Needle Insertion .....	6 and 36
		Needle Position Selector	
		Operation of .....	15

## INDEX (Cont'd)

	PAGE		PAGE
Needle Position Selector		Two Needles .....	38
Two Needle Stitching .....	38	Tension Adjustments	
Zigzag Setting .....	33	Bobbin Thread .....	25
Oiling and Lubricating .....	70-72	Needle Thread .....	24
Pleating .....	62-63	Satin Stitching .....	35
Preparing to Sew .....	19	Threading	
Pressure Adjustments .....	26	Bobbin Case .....	11
Principal Parts of Machine .....	4	Single Needle .....	12
Satin Stitching .....	34-35	Two Needle .....	37
Seam Finishes .....	50	Throat Plate	
Seams		Changing .....	14
Knit Fabric .....	49	General Purpose .....	27
Lingerie .....	48	Lifting Plate .....	46
Straight .....	20-22	Straight Stitch .....	17
SINGER Service .....	3	Winding a Bobbin .....	8-10
Stitch Controls		Zigzag Stitching	
Needle Position Selector .....	15	Control of Width .....	32
Stitch Width Selector .....	15	Equipment .....	27
Stitch Length Regulator .....	13 and 34	FASHION Discs .....	30-31
Straight Stitching		Needle Positions .....	33
Equipment and Settings .....	16-17	Operation .....	28
Secondary Positions.....	18	Two Needles .....	38